

CM100DYOD



BRJ45



BUSB30



CP100HS



CP200EE

SCB22MP1NC1



SCB300P6PCX



CP070XM



H101S30



HPMR10K2



D200YE30K



SCB30MP7C1

Control Units and Pilot Lights

B Series Control Units, 22 mm, IP 50

Flush, Spring Return



B100DY

Code	Contact Block Type	Colour*	Box/Pcs
B100D*	1 NO		10
B101D*	2 NO		10
B102D*	1 NO + 1 NC		10
B200D*	1 NC		10
B202D*	2 NC		10



B100FY

Stay-Put, Spring Return

Code	Contact Block Type	Colour*	Box/Pcs
B100F*	1 NO		10
B200F*	1 NC		10



B200HK

Extended, Spring Return

Code	Contact Block Type	Colour*	Box/Pcs
B100H*	1 NO		10
B101H*	2 NO		10
B102H*	1 NO + 1 NC		10
B200H*	1 NC		10
B202H*	2 NC		10



B132K21HB



B102K20KY

Double, Spring Return

Code	Type	Contact Block Type	Colour*	Box/Pcs
B102K20KY		1 NO + 1 NC		8
B102K21KY	Extended	1 NO + 1 NC		8
B102K20HB		1 NO + 1 NC		8
B102K21HB	Extended	1 NO + 1 NC		8



B102B20KY

Big Size Double, Spring Return

Code	Type	Contact Block Type	Colour*	Box/Pcs
B102B20HB	Flush	1 NO + 1 NC		8
B102B20KY	Flush	1 NO + 1 NC		8



B121B30YY

Triple With Extended Stop

Code	Type	Contact Block Type	Colour*	Box/Pcs
B121B30YY	Extended Stop	1 NO + 1 NC + 1 NO		8
B121B30BB	Extended Stop	1 NO + 1 NC + 1 NO		8



B100S20



B100T20

Selector

Code	Type	Contact Block Type	Position	Angle	Colour*	Box/Pcs
B100S20		1 NO	0-1	60°		10
B100S21	Spring Return	1 NO	0-1	60°		10
B101S30		2 NO	II-0-1	60°		10
B101S31	Single Spring Return	2 NO	II-0-1	60°		10
B101S32	Double Spring Return	2 NO	II-0-1	60°		10
B100R20		1 NO	0-1	45°		10
B100R21	Spring Return	1 NO	0-1	45°		10
B100T20		1 NO	0-1	90°		10
B100T21	Spring Return	1 NO	0-1	90°		10

Note 1 : For "12-30V AC/DC" Voltage in LED illumination preferences, please use the numbers; 5: White, 6:Red, 7:Blue, 8: Yellow, 9: Green, instead of "0". i.e: B260DK

Note 2 : For "48V AC/DC" Voltage in LED illumination preferences, please use the letters; Q: White, X:Red, V:Blue, W: Yellow, Z: Green, instead of "0".

Note 3 : For "100-230VAC" Voltage in LED illumination preferences, please use the letters; B: White, K:Red, M:Blue, S: Yellow, Y: Green, instead of "0". i.e: B1B0DB

Note 4 : For "110V AC/DC" Voltage in LED illumination preferences, please use the letters; C: White, D:Red, E:Blue, F: Yellow, G: Green, instead of "0".

Note 5 : Please use "3" instead of "0" for the Neon Lamp and Ba9S LED, please do not forget to add bulb



B100SL20Y

Illuminated Selector

Code	Type	Contact Block Type	Position	Colour*	Box/Pcs
B100SL20*		1 NO	0-1	(B) (K) (M) (S) (Y) (H)	10
B100SL21*	Spring Return	1 NO	0-1	(B) (K) (M) (S) (Y) (H)	10
B101SL30*		2 NO	II-0-I	(B) (K) (M) (S) (Y) (H)	10
B101SL31*	Single Spring Return	2 NO	II-0-I	(B) (K) (M) (S) (Y) (H)	10
B101SL32*	Double Spring Return	2 NO	II-0-I	(B) (K) (M) (S) (Y) (H)	10

Note 1 : For "12-30V AC/DC" Voltage in LED illumination preferences, please use the numbers; 5: White, 6:Red, 7:Blue, 8: 9: Green, instead of "0". i.e: B160SL20K

Note 2 : For "48V AC/DC" Voltage in LED illumination preferences, please use the letters; Q: White, X:Red, V:Blue, W: Yellow, instead of "0". Z: Green, Note 3 : For "100-230VAC" Voltage in LED illumination preferences, please use the letters; B: White, K:Red, M:Blue, S: Yellow, Y: Green, instead of "0". i.e: B1B0SL20B

Note 4 : For "110V AC/DC" Voltage in LED illumination preferences, please use the letters; C: White, D:Red, E:Blue, F: Yellow, G: Green, instead of "0".

Note 5 : Please use "3" instead of "0" on the middle for the Neon Lamp and Ba9S LED, please do not forget to add bulb.



B200MK



B100C

Handle and Mushroom Head

Code	Type	Contact Block Type	Colour*	Box/Pcs
B100C	Handle Switch	1 NO	●	10
B102C	Handle Switch	1 NO + 1 NC	●	10
B200C	Handle Switch	1 NC	●	10
B100M*	Mushroom Head, Spring Return	1 NO	(B) (K) (S) (Y) (H)	10
B102M*	Mushroom Head, Spring Return	1 NO + 1 NC	(B) (K) (S) (Y) (H)	10
B200M*	Mushroom Head, Spring Return	1 NC	(B) (K) (S) (Y) (H)	10

* Please choose the colour and replace (*) with the letter.



B100AC20

Key Operated

Code	Type	Contact Block Type	Position	Colour	Box/Pcs
B100AA20	Stay Put	1 NO	0-1	●	1
B102AA20	Stay Put	1 NO + 1 NC	0-1	●	1
B100AA21	Spring Return	1 NO	0-1	●	1
B101AA30	Stay Put	2 NO	II-0-I	●	1
B101AA31	Single Spring Return	2 NO	II-0-I	●	1
B101AA32	Double Spring Return	2 NO	II-0-I	●	1
B100AC20	Stay Put	1 NO	0-1	●	1
B102AC20	Stay Put	1 NO + 1 NC	0-1	●	1
B102AC30	Stay Put	1 NO + 1 NC	II-0-I	●	1

* Ω Key removal position



B200E30



B200EE



B200EG

Emergency Stop

Code	Type	Contact Block Type	Diameter	Colour*	Box/Pcs
B200E30	Turn to Release	1 NC	30	●	10
B102E30	Turn to Release	1 NO + 1 NC	30	●	10
B102E	Turn to Release	1 NO + 1 NC	40	●	10
B200E	Turn to Release	1 NC	40	●	10
B200EE	Turn to Release, With Label	1 NC	40	●	10
B200E60	Turn to Release	1 NC	60	●	5
B102E60	Turn to Release	1 NO + 1 NC	60	●	5
B200EG	With Position Cursor	1 NC	40	●	10



BPR01K

Potentiometer (1,5W@70°C IP65)

Code	Features	Colour*	Box/Pcs
BPR01K	1 kΩ (Ceramic, Wired)	●	10
BPR02K	2,2 kΩ (Ceramic, Wired)	●	10
BPR05K	5 kΩ (Ceramic, Wired)	●	10
BPR10K	10 kΩ (Ceramic, Wired)	●	10
BPR100K	100 kΩ (Ceramic, Wired)	●	10



BUSB30



BRJ45

Connection, IP65

Code	Features	Box/Pcs
BUSB	USB Connection, 1,50 Metre	1
BUSB30	Female-Female USB3.0 Connection	10
BRJ45	Female-Female Gold Plated Metal Ethernet Socket	10



SCB22MP1NC1



SCB22MP1RC1



SCB300P6PC1



SCB300P6PCX



SCB30MP7C1



SCB30MP6PSX

Touch Button, IP67

Code	Body Type	Voltage	Type	Connection	Output
SCB22MP1NC1	Dia 22 mm	10-30 V DC	Momentary	1 Metre Cable	NPN-NO
SCB22MP1NSX	Dia 22 mm	10-30 V DC	Momentary	M12 Connector	NPN-NO
SCB22MP1OC1	Dia 22 mm	10-30 V DC	Momentary	1 Metre Cable	NPN-NC
SCB22MP1OSX	Dia 22 mm	10-30 V DC	Momentary	M12 Connector	NPN-NC
SCB22MP1PC1	Dia 22 mm	10-30 V DC	Momentary	1 Metre Cable	PNP-NO
SCB22MP1PSX	Dia 22 mm	10-30 V DC	Momentary	M12 Connector	PNP-NO
SCB22MP1RC1	Dia 22 mm	10-30 V DC	Momentary	1 Metre Cable	PNP-NC
SCB22MP1RSX	Dia 22 mm	10-30 V DC	Momentary	M12 Connector	PNP-NC
SCB22MP5NC1	Dia 22 mm	10-30 V DC	Stay Put	1 Metre Cable	NPN-NO
SCB22MP5NSX	Dia 22 mm	10-30 V DC	Stay Put	M12 Connector	NPN-NO
SCB22MP5OC1	Dia 22 mm	10-30 V DC	Stay Put	1 Metre Cable	NPN-NC
SCB22MP5OSX	Dia 22 mm	10-30 V DC	Stay Put	M12 Connector	NPN-NC
SCB22MP5PC1	Dia 22 mm	10-30 V DC	Stay Put	1 Metre Cable	PNP-NO
SCB22MP5PSX	Dia 22 mm	10-30 V DC	Stay Put	M12 Connector	PNP-NO
SCB22MP5RC1	Dia 22 mm	10-30 V DC	Stay Put	1 Metre Cable	PNP-NC
SCB22MP5RSX	Dia 22 mm	10-30 V DC	Stay Put	M12 Connector	PNP-NC
SCB22UP1NC1	Dia 22 mm	10-30 V DC, Optional Lighting Colour, 5 Wired	Momentary	1 Metre Cable	NPN-NO
SCB22UP1PC1	Dia 22 mm	10-30 V DC, Optional Lighting Colour, 5 Wired	Momentary	1 Metre Cable	PNP-NO
SCB30MP6NC1	Dia 30 mm	12-30 V DC	Momentary	1 Metre Cable	NPN-NO
SCB30MP6NSX	Dia 30 mm, Round Shape	12-30 V DC	Momentary	M12 Connector	NPN-NO
SCB30MP6PC1	Dia 30 mm	12-30 V DC	Momentary	1 Metre Cable	PNP-NO
SCB30MP6PSX	Dia 30 mm, Round Shape	12-30 V DC	Momentary	M12 Connector	PNP-NO
SCB30MP7NC1	Dia 30 mm	12-30 V DC	Stay Put	1 Metre Cable	NPN-NO
SCB30MP7NSX	Dia 30 mm, Round Shape	12-30 V DC	Stay Put	M12 Connector	NPN-NO
SCB30MP7PC1	Dia 30 mm	12-30 V DC	Stay Put	1 Metre Cable	PNP-NO
SCB30MP7PSX	Dia 30 mm, Round Shape	12-30 V DC	Stay Put	M12 Connector	PNP-NO
SCB300P6NC1	Dia 30 mm, Diamond Shape	12-30 V DC	Momentary	1 Metre Cable	NPN-NO
SCB300P6NSX	Dia 30 mm, Diamond Shape	12-30 V DC	Momentary	M12 Connector	NPN-NO
SCB300P6PC1	Dia 30 mm, Diamond Shape	12-30 V DC	Momentary	1 Metre Cable	PNP-NO
SCB300P6PSX	Dia 30 mm, Diamond Shape	12-30 V DC	Momentary	M12 Connector	PNP-NO
SCB300P7NC1	Dia 30 mm, Diamond Shape	12-30 V DC	Stay Put	1 Metre Cable	NPN-NO
SCB300P7NSX	Dia 30 mm, Diamond Shape	12-30 V DC	Stay Put	M12 Connector	NPN-NO
SCB300P7PC1	Dia 30 mm, Diamond Shape	12-30 V DC	Stay Put	1 Metre Cable	PNP-NO
SCB300P7PSX	Dia 30 mm, Diamond Shape	12-30 V DC	Stay Put	M12 Connector	PNP-NO
SCB30UP6PC1	Dia 30 mm	12-30 V DC, PLC Control 6 Wired	Momentary	1 Metre Cable	PNP-NO



B080XS

B Series Pilot Lights with Contact Block, IP50

Code	Illumination	Nominal Voltage	Colour*	Box/Pcs
B030X*	With Lampholder forBa9S		(B) (K) (M) (S) (Y)	10
B050XB	LED	12 - 30V AC/DC	(B)	10
B060XK	LED	12 - 30V AC/DC	(K)	10
B070XM	LED	12 - 30V AC/DC	(M)	10
B080XS	LED	12 - 30V AC/DC	(S)	10
B090XY	LED	12 - 30V AC/DC	(Y)	10
B0Q0XB	LED	48V AC/DC	(B)	10
B0V0XM	LED	48V AC/DC	(M)	10
B0W0XS	LED	48V AC/DC	(S)	10
B0X0XK	LED	48V AC/DC	(K)	10
B0Z0XY	LED	48V AC/DC	(Y)	10
B0B0XB	LED	100-230V AC	(B)	10
B0K0XK	LED	100-230V AC	(K)	10
B0M0XM	LED	100-230V AC	(M)	10
B0S0XS	LED	100-230V AC	(S)	10
B0Y0XY	LED	100-230V AC	(Y)	10
B0C0XB	LED	110V AC/DC	(B)	10
B0D0XK	LED	110V AC/DC	(K)	10
B0E0XM	LED	110V AC/DC	(M)	10
B0F0XS	LED	110V AC/DC	(S)	10
B0G0XY	LED	110V AC/DC	(Y)	10

Note: B030X* doesn't have lamp. Please choose Ba9s LED from Page 9. *Please choose the colour and replace (*) with the letter.



B3



B1



BDDH



BDAA20



BDS20



BDK20KY



BDSL20Y



BDE60



BDC



BK



BDMH



BEBK20



BEB



LED220K



LED24S

Spare Parts of B Series

Code	Type	Features	Position	Colour*	Box/ Pcs
B1	Contact Block	1 NO		20	20
B2	Contact Block	1 NC		20	20
B3	Contact Block	Contact Block for Illumination		20	20
BDD*	Button Actuator	Flush			20
BDF*	Button Actuator	Stay Put			20
BDH*	Button Actuator	Extended			20
BDM*	Button Actuator	Mushroom			20
BDS20	Button Actuator	Selector	0-1		20
BDS21	Button Actuator	Selector, Spring Return	0-1		20
BDS30	Button Actuator	Selector	II-0-I		20
BDAC20	Button Actuator	Key Operated, Stay Put	0-1		10
BDAA20	Button Actuator	Key Operated, Stay Put	0-1		10
BDAC30	Button Actuator	Key Operated, Stay Put	II-0-I		10
BDAA30	Button Actuator	Key Operated, Stay Put	II-0-I		10
BDSL20*	Button Actuator	Illuminated Selector	0-1		10
BDSL30*	Button Actuator	Illuminated Selector	II-0-I		10
BDB20KY	Button Actuator	Big, Double			8
BDB30YY	Button Actuator	Double with Extended Stop Button			8
BDK20KY	Button Actuator	Double			8
BDK21KY	Button Actuator	Double, Extended			8
BDK20HB	Button Actuator	Double			8
BDK21HB	Button Actuator	Double, Extended			8
BDC	Button Actuator	Handle			20
BDE	Button Actuator	Emergency Stop, 40 mm			10
BDEE	Button Actuator	Emergency Stop, 40 mm, With Label			10
BDEG	Button Actuator	Emergency Stop, 40 mm With Position Cursor			10
BDE30	Button Actuator	Emergency Stop Cylindrical, 30 mm			10
BDE60	Button Actuator	Emergency Stop, 60 mm			5
TIPASOM	Stopper and Nut				100
BDX*	Pilot	Combination			20
B5	Illumination Block with LED	12-30V AC/DC			20
B6	Illumination Block with LED	12-30V AC/DC			20
B7	Illumination Block with LED	12-30V AC/DC			20
B8	Illumination Block with LED	12-30V AC/DC			20
B9	Illumination Block with LED	12-30V AC/DC			20
BQ	Illumination Block with LED	48V AC/DC			20
BV	Illumination Block with LED	48V AC/DC			20
BW	Illumination Block with LED	48V AC/DC			20
BX	Illumination Block with LED	48V AC/DC			20
BZ	Illumination Block with LED	48V AC/DC			20
BB	Illumination Block with LED	100-230V AC			20
BK	Illumination Block with LED	100-230V AC			20
BM	Illumination Block with LED	100-230V AC			20
BS	Illumination Block with LED	100-230V AC			20
BY	Illumination Block with LED	100-230V AC			20
BC	Illumination Block with LED	110V AC/DC			20
BD	Illumination Block with LED	110V AC/DC			20
BE	Illumination Block with LED	110V AC/DC			20
BF	Illumination Block with LED	110V AC/DC			20
BG	Illumination Block with LED	110V AC/DC			20
BN	Illumination Block with LED	220V DC			20
BO	Illumination Block with LED	220V DC			20
BP	Illumination Block with LED	220V DC			20
BR	Illumination Block with LED	220V DC			20
BT	Illumination Block with LED	220V DC			20
BA	Adapter				100
BEB	Silicon Cover	For Single Buttons			20
BEBK20	Silicon Cover	For Double Buttons			20
BEBK21	Silicon Cover	For Extended Double Buttons			20
LED24*	Ba9S LED	24 V AC/DC			50
LED220*	Ba9S LED	220V AC			50
BBUTONORTA	Contact Block Activator				50
BSECICIORTA	Contact Block Activator				50

Please choose the colour and replace () with the letter.



CP100DY



CP200DK



CP100DM



CP305DY



CP100FK



CP100FY



CP100HS



CP100HK



CP102K21KY



CP102K20KY



CP170S20



CP100S20



CP100MS



CP100MY



CP200EA30



CP200EP



CP200ECN30



CP200EE



CP200E



CP200EK30

CP Series Plastic Control Units, 22 mm, IP 65

Flush, Spring Return

Code	Contact Block Type	Colour*	Box/Pcs
CP100D*	1 NO	(B) (K) (M) (S) (Y) (H)	10
CP101D*	2 NO	(B) (K) (M) (S) (Y) (H)	10
CP102D*	1 NO + 1 NC	(B) (K) (M) (S) (Y) (H)	10
CP200D*	1 NC	(B) (K) (M) (S) (Y) (H)	10
CP202D*	2 NC	(B) (K) (M) (S) (Y) (H)	10
CP303D*	2 NO + 2 NO	(B) (K) (M) (S) (Y) (H)	5
CP305D*	2 NO + 2 NC	(B) (K) (M) (S) (Y) (H)	5

Stay Put, Spring Return

Code	Contact Block Type	Colour*	Box/Pcs
CP100F*	1 NO	(B) (K) (M) (S) (Y) (H)	10
CP200F*	1 NC	(B) (K) (M) (S) (Y) (H)	10

Extended, Spring Return

Code	Contact Block Type	Colour*	Box/Pcs
CP100H*	1 NO	(B) (K) (M) (S) (Y) (H)	10
CP101H*	2 NO	(B) (K) (M) (S) (Y) (H)	10
CP102H*	1 NO + 1 NC	(B) (K) (M) (S) (Y) (H)	10
CP200H*	1 NC	(B) (K) (M) (S) (Y) (H)	10
CP202H*	2 NC	(B) (K) (M) (S) (Y) (H)	10

Double, Spring Return

Ürün Kodu	Tip	Contact Block Type	Colour*	Box/Pcs
CP102K20KY		1 NO + 1 NC	(R) (G)	8
CP102K20HB		1 NO + 1 NC	(R) (W)	8
CP102K21KY	Extended	1 NO + 1 NC	(R) (G)	8
CP102K21HB	Extended	1 NO + 1 NC	(R) (W)	8

Selector

Code	Type	Contact Block Type	Position	Colour*	Box/Pcs
CP100S20		1 NO	0-1 ↓	(●)	10
CP100S21	Spring Return	1 NO	0-1 ↗	(●)	10
CP101S30		2 NO	II-0-1 ↓	(●)	10
CP303S30		2 NO + 2 NO	II-0-1 ↓	(●)	5
CP305S30		2 NO + 2 NC	II-0-1 ↓	(●)	5
CP101S31	Single Spring Return	2 NO	II-0-1 ↓	(●)	10
CP101S32	Double Spring Return	2 NO	II-0-1 ↓	(●)	10

Mushroom, Spring Return

Code	Type	Contact Block Type	Colour*	Box/Pcs
CP100M*	Mushroom, Spring Return	1 NO	(B) (K) (M) (S) (Y) (H)	10
CP102M*	Mushroom, Spring Return	1NO + 1NC	(B) (K) (M) (S) (Y) (H)	10
CP200M*	Mushroom, Spring Return	1 NC	(B) (K) (M) (S) (Y) (H)	10

Emergency Stop

Code	Type	Contact Block Type	Dia (mm)	Colour*	Box/Pcs
CP200E30	Turn to Release	1 NC	30	(●)	10
CP200ES30	Turn to Release, With Signal	1 NC	30	(●)	10
CP200EA30	Turn to Release, Key Operated	1 NC	30	(●)	10
CP200ECN30	Pull to Release	1 NC	30	(●)	10
CP200ECS30	With Signal, Pull to Release	1 NC	30	(●)	10
CP200E	Turn to Release	1 NC	40	(●)	10
CP200EP	Pull to Release	1 NC	40	(●)	10
CP200EE	With Label	1 NC	40	(●)	10
CP200EK30	Turn to Release-Short	1 NC	30	(●)	10
CP200EC	Pull to Release	1 NC	40	(●)	10

Note 1 : For "12-30V AC/DC" Voltage in LED illumination preferences, please use the numbers; 5: White, 6:Red, 7:Blue, 8: Yellow, 9: Green, instead of "0". i.e: CP160S20

Note 2 : For "48V AC/DC" Voltage in LED illumination preferences, please use the letters; Q: White, X:Red, V:Blue, W: Yellow, Z: Green, instead of "0".

Note 3 : For "100-230VAC" Voltage in LED illumination preferences, please use the letters; B: White, K:Red, M:Blue, S: Yellow, Y: Green, instead of "0". i.e: CP1B0DB

Note 4 : For "110V AC/DC" Voltage in LED illumination preferences, please use the letters; C: White, D:Red, E:Blue, F: Yellow, G: Green, instead of "0".



CP100AC20

Key Operated

Code	Type	Contact Block Type	Position	Colour	Box/Pcs
CP100AA20		1 NO	0-1	●	10
CP100AA21	Spring Return	1 NO	0-1	●	10
CP101AA21	Spring Return	2 NO	0-1	●	10
CP101AA30	Stay Put	2 NO	II-0-1	●	10
CP102AA30		1 NO + 1 NC	II-0-1	●	10
CP101AA31	Single Spring Return	2 NO	II-0-1	●	10
CP101AA32	Double Spring Return	2 NO	II-0-1	●	10
CP100AC20		1 NO	0-1	●	10
CP101AC20	Stay Put	2 NO	0-1	●	10
CP100AC21	Spring Return	1 NO	0-1	●	10
CP101AC30	Stay Put	2 NO	II-0-1	●	10
CP102AC30		1 NO + 1 NC	II-0-1	●	10
CP101AC31	Single Spring Return	2 NO	II-0-1	●	10
CP101AC32	Double Spring Return	2 NO	II-0-1	●	10

* Ω Key withdrawal position



CP707DJ40

Joystick

Code	Type	Position	Colour	Box/Pcs
CP101DJ20		2 Pos.	●	1
CP101DJ21	Spring Return	2 Pos.	●	1
CP707DJ40		4 Pos.	●	1
CP707DJ41	Spring Return	4 Pos.	●	1



CPPR02K



CPPR05K

Potentiometer (1,5W@70°C IP65)

Code	Features	Colour	Box/Pcs
CPPR01K	1 kΩ (Ceramic, Wired)	●	10
CPPR02K	2,2 kΩ (Ceramic, Wired)	●	10
CPPR05K	5 kΩ (Ceramic, Wired)	●	10
CPPR10K	10 kΩ (Ceramic, Wired)	●	10
CPPR100K	100 kΩ (Ceramic, Wired)	●	10



CP060XK



CP070XM



CP080XS



CP090XY

CP Series Pilot Lights with Lamp Block

Code	Illumination	Nominal Voltage	Colour	Box/Pcs
CP050XB	LED	12 - 30V AC/DC	○	10
CP060XK	LED	12 - 30V AC/DC	●	10
CP070XM	LED	12 - 30V AC/DC	●	10
CP080XS	LED	12 - 30V AC/DC	●	10
CP090XY	LED	12 - 30V AC/DC	●	10
CP0Q0XB	LED	48V AC/DC	○	10
CP0V0XM	LED	48V AC/DC	●	10
CP0W0XS	LED	48V AC/DC	●	10
CP0X0XK	LED	48V AC/DC	●	10
CP0Z0XY	LED	48V AC/DC	●	10
CP0B0XB	LED	100-230V AC	○	10
CP0K0XK	LED	100-230V AC	●	10
CP0M0XM	LED	100-230V AC	●	10
CP0S0XS	LED	100-230V AC	●	10
CP0Y0XY	LED	100-230V AC	●	10
CP0C0XB	LED	110V AC/DC	○	10
CP0D0XK	LED	110V AC/DC	●	10
CP0E0XM	LED	110V AC/DC	●	10
CP0F0XS	LED	110V AC/DC	●	10
CP0G0XY	LED	110V AC/DC	●	10
CP0N0XB	LED	220V DC	○	10
CP0O0XK	LED	220V DC	●	10
CP0P0XM	LED	220V DC	●	10
CP0R0XS	LED	220V DC	●	10
CP0T0XY	LED	220V DC	●	10

CM Series Metal Control Units, 22 mm, IP 65



CM100DY



CM200DK

Flush, Spring Return

Code	Contact Block Type	Colour	Box/Pcs
CM100D*	1 NO		10
CM101D*	2 NO		10
CM102D*	1 NO + 1 NC		10
CM200D*	1 NC		10
CM202D*	2 NC		10
CM305D*	2 NO + 2 NC		5

* Please choose the colour and replace (*) with the letter.



CM100HK



CM100HY

Extended, Spring Return

Code	Contact Block Type	Colour	Box/Pcs
CM100H*	1 NO		10
CM101H*	2 NO		10
CM102H*	1 NO + 1 NC		10
CM200H*	1 NC		10
CM202H*	2 NC		10



CM102K21KY



CM102K20KY

Double, Spring Return

Code	Type	Contact Block Type	Colour	Box/Pcs
CM102K20KY		1 NO + 1 NC		8
CM102K20HB		1 NO + 1 NC		8
CM102K21KY	Double Extended	1 NO + 1 NC		8
CM102K21HB	Double Extended	1 NO + 1 NC		8



CM190S20



CM100S20

Selector

Code	Type	Contact Block Type	Position	Colour	Box/Pcs
CM100S20		1 NO	0-1		10
CM100S21	Spring Return	1 NO	0-1		10
CM101S30		2 NO	II-0-1		10
CM303S30		2 NO + 2 NO	II-0-1		10
CM101S31	Single Spring Return	2 NO	II-0-1		10
CM101S32	Double Spring Return	2 NO	II-0-1		10

Note 1 : For "12-30V AC/DC" Voltage in LED illumination preferences, please use the numbers; 5: White, 6:Red, 7:Blue, 8: Yellow, 9: Green, instead of "0". i.e: CM160S20

Note 2 : For "48V AC/DC" Voltage in LED illumination preferences, please use the letters; Q: White, X:Red, V:Blue, W: Yellow, Z: Green, instead of "0".

Note 3 : For "100-230VAC" Voltage in LED illumination preferences, please use the letters; B: White, K:Red, M:Blue, S: Yellow, Y: Green, instead of "0". i.e: CM1B0DB

Note 4 : For "110V AC/DC" Voltage in LED illumination preferences, please use the letters; C: White, D:Red, E:Blue, F: Yellow, G: Green, instead of "0".



CM100MH



CM100MY

Mushroom, Spring Return

Code	Type	Contact Block Type	Colour*	Box/Pcs
CM100M*	Mushroom, Spring Return	1 NO		10
CM102M*	Mushroom, Spring Return	1NO + 1NC		10
CM200M*	Mushroom, Spring Return	1 NC		10



CM200E



CM200EE

Emergency Stop

Code	Type	Contact Block Type	Dia (mm)	Colour	Box/Pcs
CM200E	Turn to Release	1 NC	40		10
CM200EE	Turn to Release, With Label	1 NC	40		10
CM200EK30	Short, Turn to Release	1 NC	30		10



CM112AA20



CM100AC20

Key Operated

Code	Type	Contact Block Type	Position	Colour	Box/Pcs
CM100AA20		1 NO	0-I	●	10
CM112AA20		2 NO + 1 NC	0-I	●	10
CM100AA21	Spring Return	1 NO	0-I	●	10
CM102AA30		1 NO + 1 NC	II-0-I	●	10
CM101AA31	Single Spring Return	2 NO	II-0-I	●	10
CM101AA32	Double Spring Return	2 NO	II-0-I	●	10
CM102AA20		1 NO + 1 NC	0-I	●	10
CM100AC20		1 NO	0-I	●	10
CM102AC20		1 NO + 1 NC	0-I	●	10
CM102AC30		1 NO + 1 NC	II-0-I	●	10

* Ω Key removal position



CM707DJ40

Joystick

Code	Type	Position	Colour	Box/Pcs
CM101DJ20		2 Pos.	●	1
CM101DJ21	Spring Return	2 Pos.	●	1
CM707DJ40		4 Pos.	●	1
CM707DJ41	Spring Return	4 Pos.	●	1



CM090XY



CM060XK



CM070XM



CM080XS

CM Series Pilot Lights with Lamp Block

Code	Illumination	Nominal Voltage	Colour	Box/Pcs
CM050XB	LED	12 - 30V AC/DC	○	10
CM060XK	LED	12 - 30V AC/DC	●	10
CM070XM	LED	12 - 30V AC/DC	●	10
CM080XS	LED	12 - 30V AC/DC	●	10
CM090XY	LED	12 - 30V AC/DC	●	10
CM0Q0XB	LED	48V AC/DC	○	10
CM0V0XM	LED	48V AC/DC	●	10
CM0W0XS	LED	48V AC/DC	●	10
CM0X0XK	LED	48V AC/DC	●	10
CM0Z0XY	LED	48V AC/DC	●	10
CM0B0XB	LED	100-230V AC	○	10
CM0K0XK	LED	100-230V AC	●	10
CM0M0XM	LED	100-230V AC	●	10
CM0S0XS	LED	100-230V AC	●	10
CM0Y0XY	LED	100-230V AC	●	10
CM0C0XB	LED	110V AC/DC	○	10
CM0D0XK	LED	110V AC/DC	●	10
CM0E0XM	LED	110V AC/DC	●	10
CM0F0XS	LED	110V AC/DC	●	10
CM0G0XY	LED	110V AC/DC	●	10
CM0N0XB	LED	220V DC	○	10
CM0O0XK	LED	220V DC	●	10
CM0P0XM	LED	220V DC	●	10
CM0R0XS	LED	220V DC	●	10
CM0T0XY	LED	220V DC	●	10

Spare Parts for CP/CM Series Control Units



C1



C2



C11



C12



C3BK



C3CK



C4BK



C4CK



CPDXX



CPDS20



CPDDY

Code	Type	Features	Colour	Box/Pcs
C1	Contact Block	1 NO	●	20
C2	Contact Block	1 NC	●	20
C1AU	Gold Plated Contact Block	1 NO	●	20
C2AU	Gold Plated Contact Block	1 NC	●	20
C11	Contact Block	2 NO	●	20
C12	Joystick Contact Block	2 NO	●	20
C3BK	Contact Block for Control Boxes (B Series)	1 NO	●	20
C4BK	Contact Block for Control Boxes (B Series)	1 NC	●	20
C3CK	Contact Block for Control Boxes (C Series)	1 NO	●	20
C4CK	Contact Block for Control Boxes (C Series)	1 NC	●	20
CPDD*	Plastic, Flush	IP65	● B ● K ● M ● S ● Y ● H	20
CPDF*	Plastic, Stay Put	IP65	● B ● K ● M ● S ● Y ● H	20
CPDH*	Plastic-Extended	IP65	● B ● K ● M ● S ● Y ● H	20
CPDM*	Plastic, Mushroom	IP65	● B ● K ● S ● Y ● H	20
CPDM72*	Plastic, Mushroom	IP65	● K ● H	20
CPDS20	Selector - Plastic	IP65	●	20
CPDS30	Selector - Plastic	IP65	●	20
CPDX*	Pilot - Plastic	IP65	● B ● K ● M ● S ● Y	20
CPDE	Emergency Stop Head	IP65 - Turn to Release	●	20
CPDE30	Emergency Stop Head	IP65 - Turn to Release	●	20
CPDEA30	Emergency Stop Head	IP65 - Key Operated	●	20
CPDECN30	Emergency Stop Head	IP65 - Pull to Release	●	20
CPDES30	Emergency Stop Head	IP65 - With Signal	●	20
CMDD*	Metal-Flush	IP65	● B ● K ● M ● S ● Y ● H	20
CMDH*	Metal-Extended	IP65	● B ● K ● M ● S ● Y ● H	20
CMDM*	Metal, Mushroom	IP65	● K ● S ● Y ● H	20
CMDS20	Selector - Metal	IP65	●	20
CMDS30	Selector - Metal	IP65	●	20
CMDX*	Pilot - Metal	IP65	● B ● K ● M ● S ● Y	20
CMDE	Emergency Stop Head	IP65 - Turn to Release	●	20

* Please choose the colour and replace (*) with the letter. Example: CMDXY.

CP/CM Series Spares

For Control Units / For Control Boxes



CBB



CA

Code	Type	Features	Colour	Box/Pcs
CB5 / CK5	Illumination Block with LED	12-30V AC/DC	○	20
CB6 / CK6	Illumination Block with LED	12-30V AC/DC	●	20
CB7 / CK7	Illumination Block with LED	12-30V AC/DC	●	20
CB8 / CK8	Illumination Block with LED	12-30V AC/DC	●	20
CB9 / CK9	Illumination Block with LED	12-30V AC/DC	●	20
CBQ / CKQ	Illumination Block with LED	48V AC/DC	○	20
CBX / CKX	Illumination Block with LED	48V AC/DC	●	20
CBV / CKV	Illumination Block with LED	48V AC/DC	●	20
CBW / CKW	Illumination Block with LED	48V AC/DC	●	20
CBZ / CKZ	Illumination Block with LED	48V AC/DC	●	20
CBB / CKB	Illumination Block with LED	100-230V AC	○	20
CBK / CKK	Illumination Block with LED	100-230V AC	●	20
CBM / CKM	Illumination Block with LED	100-230V AC	●	20
CBS / CKS	Illumination Block with LED	100-230V AC	●	20
CBY / CKY	Illumination Block with LED	100-230V AC	●	20
CBC / CKC	Illumination Block with LED	110V AC/DC	○	20
CBD / CKD	Illumination Block with LED	110V AC/DC	●	20
CBE / CKE	Illumination Block with LED	110V AC/DC	●	20
CBF / CKF	Illumination Block with LED	110V AC/DC	●	20
CBG / CKG	Illumination Block with LED	110V AC/DC	●	20
CBN	Illumination Block with LED	220V DC	○	20
CBO	Illumination Block with LED	220V DC	●	20
CBP	Illumination Block with LED	220V DC	●	20
CBR	Illumination Block with LED	220V DC	●	20
CBT	Illumination Block with LED	220V DC	●	20
CA	Adapter			20
CEA	Additional Adapter			10
CEB	Silicon Cover For Single Buttons			20
CBUTONORTA	Contact Block Activator			20
CSECICIORTA	Contact Block Activator			20

Pad Printed Control Units (matt surface without illumination)



CM101K20YYOK CM100DYOD



CEB

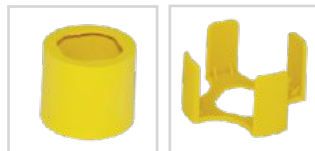

BPROT BMUHAFAZA



BET60P BPUL



BET60LED1 BET60LED2



BET60FLASH1 BET60FLASH2



BROZET18 BROZET08



BARP EMNKAPAK

CODE								
PRINT	B102K20KY10	B101K20YY12	B101K20YYOK	B102K20HB10	B101K20HHOK	B101K20BB12	B101K20SH10	B101K20SS12
CODE								
PRINT	B100DYOD	B100DYOY	B100DHOD	B100DHOY	B100DBOD	B100DBOY	B100DBZ	B100DBL
CODE								
PRINT	B100DY1	B100DY2	B100DB1	B100DB2	B200DK0	B200DH0	B200DSZ	B200DSL
PRINT	CM100DY1	CM100DY2	CM100DB1	CM100DB2	CM200DK0	CM200DH0	CM200DSZ	CM200DSL
PRINT	MB100DY1	MB100DY2	MB100DB1	MB100DB2	MB200DK0	MB200DH0	MB200DSZ	MB200DSL
	I	II	I	II	O	O	Bell	Lamp

Note : Minimum Order Quantity : 50 pcs

Accessories for B and C Series Control Units

Code	Type	Features	Box/ Pcs
BROZET08	Legend Plate Holder		100
BROZET18	Legend Plate Holder		100
BCIFLTIROZET18	Double Legend Plate Holder		100
BET08	Legend Plate	Unmarked	100
BET18	Legend Plate	Unmarked	100
BET08START	Legend Plate	(START) Marked	100
BET08STOP	Legend Plate	(STOP) Marked	100
BET0801	Legend Plate	(0-I) Marked	100
BET0801OK	Legend Plate	(0-I) (Arrow) Sign Marked	100
BET08201	Legend Plate	(II-0-I) Marked	100
BET08201OK	Legend Plate	(II-0-I) (Arrow) Sign Marked	100
BET080	Legend Plate, Transparent	Unmarked	100
BET180	Legend Plate, Transparent	Unmarked	100
BET60P	Legend Plate, Plastic	(EMERGENCY STOP) Marked	10
BET90P	Legend Plate, Plastic	(EMERGENCY STOP) Marked	10
BET60A	Legend Plate, Aluminium	(EMERGENCY STOP) Marked	10
BET90A	Legend Plate, Aluminium	(EMERGENCY STOP) Marked	10
BET60LED0	Legend Plate, Constant Blinking LED,Plastic	Empty	1
BET60LED2	Legend Plate, Constant Blinking LED,Plastic	(EMERGENCY-EMERGENCY) Marked	1
BET60LED4	Legend Plate, Constant Blinking LED,Plastic	(NOUZOVY STOP) Marked	1
BET60FLASH0	Legend Plate, Flash Blinking LED,Plastic	Empty	1
BET60FLASH2	Legend Plate, Flash Blinking LED,Plastic	(EMERGENCY-EMERGENCY) Marked	1
BET60FLASH3	Legend Plate, Flash Blinking LED,Plastic	(Attention) Sign Marked	1
BMUHAFAZA	Emergency Protective Cover	Protection Guard	1
CMUHAFAZA	Emergency Protective Cover	Protection Guard	1
BPUL	Plate	Button Tightening	20
TIPASOM	Stopper and Nut	2 options Black and Gray	20
BEB	Silicon Button Cover for B Series	For Single Buttons	20
CEB	Silicon Button Cover for C Series	For Single Buttons	20
BEBK20	Silicon Button Cover	For Double Buttons	20
BEBK21	Silicon Button Cover	For Extended Double Buttons	20
BPROT	Protective Cover		24
BSOMAN	Nut Tightener		10
BARP	DIN Rail Adapter for M22 Control Units		1
EMNKAPAK	Emergency Safety Cover		1



BET08201OK2

BET08201OK

BET08

BET18

BET08START

BET08STOP

BET0801

BET0801OK

BET08201

D Series Control Units, 16 mm, IP 50

Rectangle, Spring Return



Code	Contact Block Type	Colour*	Box/Pcs
D100DD*	1 NO		10
D101DD*	2 NO		10
D102DD*	1 NO + 1 NC		10
D200DD*	1 NC		10
D202DD*	2 NC		10

Square, Spring Return



Code	Contact Block Type	Colour*	Box/Pcs
D100KD*	1 NO		10
D101KD*	2 NO		10
D102KD*	1 NO + 1 NC		10
D200KD*	1 NC		10
D202KD*	2 NC		10

Round, Spring Return



Code	Contact Block Type	Colour*	Box/Pcs
D100YD*	1 NO		10
D101YD*	2 NO		10
D102YD*	1 NO + 1 NC		10
D200YD*	1 NC		10
D202YD*	2 NC		10

Round, Selector



Code	Type	Contact Block Type	Position	Colour	Box/Pcs
D100YS20		1 NO	0-1		10
D100YS21	Spring Return	1 NO	0-1		10
D101YS30		2 NO	II-0-1		10
D101YS31	Single Spring Return	2 NO	II-0-1		10
D101YS32	Double Spring Return	2 NO	II-0-1		10

Mushroom, Spring Return



Code	Contact Block Type	Colour*	Box/Pcs
D100YM30*	1 NO		10
D102YM30*	1 NO + 1 NC		10
D200YM30*	1 NC		10

Emergency Stop



Code	Contact Block Type	Colour*	Box/Pcs
D100YE30K	1 NO		10
D102YE30K	1 NO + 1 NC		10
D200YE30K	1 NC		10

D Serisi Yedekleri



Code	Contact Block Type	Colour*	Box/Pcs
D1	1 NO		10
D2	1 NC		10
D5	24V AC/DC		10
D6	24V AC/DC		10
D7	24V AC/DC		10
D8	24V AC/DC		10
D9	24V AC/DC		10
DA	Button Adapter		10



HPMR10K2

Potentiometer - Digital Display (1,5W@70°C IP65)

Code	Range	Number of Turns	Operational Voltage	Output Voltage	Box/Pcs
HPMR01K1	1 KΩ	Multi Turn	24V DC	10 V DC	1
HPMR02K1	2 KΩ	Multi Turn	24V DC	10 V DC	1
HPMR05K1	5 KΩ	Multi Turn	24V DC	10 V DC	1
HPMR10K1	10 KΩ	Multi Turn	24V DC	10 V DC	1
HPMR01K2	1 KΩ	Multi Turn	24V DC	24 V DC	1
HPMR02K2	2 KΩ	Multi Turn	24V DC	24 V DC	1
HPMR05K2	5 KΩ	Multi Turn	24V DC	24 V DC	1
HPMR10K2	10 KΩ	Multi Turn	24V DC	24 V DC	1

KB Series Control Units, 22 mm, IP 40

Flush, Spring Return



KB34DY



KB14RS-0

Code	Type	Contact Block Type	Colour	Box/Pcs
KB12D*		1 NC	(B) (K) (M) (S) (Y)	10
KB34D*		1 NO	(B) (K) (M) (S) (Y)	10
KB14D*		1 NC + 1 NO	(B) (K) (M) (S) (Y)	10
KB12R*	With Silicon Cover	1 NC	(B) (K) (M) (S) (Y)	10
KB34R*	With Silicon Cover	1 NO	(B) (K) (M) (S) (Y)	10
KB14R*	With Silicon Cover	1 NC + 1 NO	(B) (K) (M) (S) (Y)	10
KB14R*0	With Silicon Cover, With Arrow	1 NC + 1 NO	(B) (K) (M) (S) (Y)	10
KB34R*0	With Silicon Cover, With Arrow	1 NO	(B) (K) (M) (S) (Y)	10
KB12R*0	With Silicon Cover, With Arrow	1 NC	(B) (K) (M) (S) (Y)	10

Selector



KB34S2

Code	Contact Block Type	Colour	Box/Pcs
KB34S2	1 NO	●	10
KB14S2	1 NO + 1 NC	●	10

Handle



KB12C

Code	Contact Block Type	Colour	Box/Pcs
KB12C	1 NC	(B)	10
KB34C	1 NO	(B)	10
KB14C	1 NO + 1 NC	(B)	10

Key Operated



KB14A2

Code	Contact Block Type	Colour	Box/Pcs
KB14A2	1 NO + 1 NC	●	1

Mushroom



KB12MK

Code	Contact Block Type	Colour	Box/Pcs
KB12M*	1 NC	(K) (S) (Y)	10
KB34M*	1 NO	(K) (S) (Y)	10
KB14M*	1 NO + 1 NC	(K) (S) (Y)	10

Acil Stop Tip



KB12E

Code	Type	Contact Block	Colour	Box/Pcs
KB12E	Turn to Release	1 NC	●	10
KB14E	Turn to Release	1 NO + 1 NC	●	10

Spare Parts for KB Series Control Units



KB12

Code	Type	Contact Block	Colour	Box/Pcs
KB12	Contact Block	1 NC		100
KB34B	Contact Block	1 NO		100
KB14B	Contact Block, For Push Button	1 NO + 1 NC		100
KB14K	Contact Block, For Box	1 NO + 1 NC		100
D*	Button Head		(B) (K) (M) (S) (Y)	100

Please choose the colour and replace () with the letter.

MB Series Monoblock Control Units, 22 mm, IP 50



MB102DM



MB100DY

Flush, Spring Return

Code	Contact Block	Colour	Box/Pcs
MB100D*	1 NO		10
MB102D*	1 NO + 1 NC		10
MB200D*	1 NC		10
MB101D*	2 NO		10
MB202D*	2 NC		10



MB100FY

Stay-Put, Spring Return

Code	Contact Block	Colour	Box/Pcs
MB100F*	1 NO		10
MB200F*	1 NC		10
MB101F*	2 NO		10
MB102F*	1 NO + 1 NC		10



MB100HY

Extended, Spring Return

Code	Contact Block	Colour	Box/Pcs
MB100H*	1 NO		10
MB101H*	2 NO		10
MB102H*	1 NO + 1 NC		10
MB200H*	1 NC		10
MB202H*	2 NC		10



MB100S20

Code	Type	Contact Block	Position	Degree	Colour	Box/Pcs
MB100S20		1 NO	0-1	60°		10
MB100S21	Spring Return	1 NO	0-1	60°		10
MB101S30		2 NO	II-0-I	60°		10
MB101S31	Single Spring Return	2 NO	II-0-I	60°		10
MB101S32	Double Spring Return	2 NO	II-0-I	60°		10



MB200E



MB200EE

Emergency Stop

Code	Type	Contact Block	Diameter	Colour	Box/Pcs
MB200E	Turn to Release	1 NC	40		10
MB202E	Turn to Release	2 NC	40		10
MB200EE	With Label, Turn to Release	1 NC	40		10
MB202EE	With Label, Turn to Release	2 NC	40		10



MB200MK

Mushroom Head

Code	Contact Block	Colour	Box/Pcs
MB100M*	1 NO		10
MB101M*	2 NO		10
MB102M*	1 NO + 1 NC		10
MB200M*	1 NC		10
MB202M*	2 NC		10



MBSD024Y



MBSP220M

Monoblock Pilot Lights (LED) IP54

Code	Features	Nominal Voltage	Colour	Box/Pcs
MBSD012*	Flat	12V AC/DC		10
MBSD024*	Flat	24V AC/DC		10
MBSD110*	Flat	110V AC		10
MBSD220*	Flat	220V AC		10
MBSP012*	Cellular	12V AC/DC		10
MBSP024*	Cellular	24V AC/DC		10
MBSP110*	Cellular	110V AC		10
MBSP220*	Cellular	220V AC		10

Please choose the colour and replace () with the letter.



MBSD024S



MBSP110K

Monoblock Buzzers IP50



MBZS024S



MBZX220S

MB Series Ø 22 mm Monoblock Buzzer (LED), 90 db(10 cm Distance)

Code	Features	Nominal Voltage	Box/Pcs
MBZS012S	With LED Illumination	12V AC/DC	10
MBZS024S	With LED Illumination	24V AC/DC	10
MBZS110S	With LED Illumination	110V AC	10
MBZS220S	With LED Illumination	220V AC	10
MBZX012S		12V AC/DC	10
MBZX024S		24V AC/DC	10
MBZX110S		110V AC	10
MBZX220S		220V AC	10

Note: For IP65 preferences, please add "E" letter to end of the code.
In case of IP65 preferences, volume will be decreased 5 db.



S100LK



S102NS



S140NK



S224NB



S140NY2



S222LS



S106N

Pilot Lights

Code	Dia (mm)	Illumination	Features	Voltage	Colour	Box/Pcs
S060N*	6	Bulb	12cm Cable	230V AC	(B) (K) (M) (S) (Y)	100
S100N*	10	Bulb	12cm Cable	230V AC	(B) (K) (M) (S) (Y)	100
S100L*	10	LED	12cm Cable	230V AC	(B) (K) (M) (S) (Y)	100
S100L*1	10	LED	12cm Cable	12V AC/DC	(B) (K) (M) (S) (Y)	100
S100L*2	10	LED	12cm Cable	24V AC/DC	(B) (K) (M) (S) (Y)	100
S100N*5SP0	10	Bulb	12cm, With Silicon Cable	230V AC	(B) (K) (M) (S) (Y)	100
S102N*	10	Bulb	With Terminal	230V AC	(B) (K) (M) (S) (Y)	50
S105N*	10	Bulb	Nutless, with Terminal	230V AC	(B) (K) (M) (S) (Y)	50
S106N*	10	Bulb	Nutless, with Cable	230V AC	(B) (K) (M) (S) (Y)	100
S140N*	14	Bulb	With Terminal	230V AC	(B) (K) (M) (S) (Y)	50
S140N*1	14	Bulb	With Terminal	12V DC	(B) (K) (M) (S) (Y)	50
S140N*2	14	Bulb	With Terminal	24V DC	(B) (K) (M) (S) (Y)	50
S145N*	14	Bulb	Hooked	230V AC	(B) (K) (M) (S) (Y)	50
S220N*	22	Bulb	Conic Glass	230V	(B) (K) (M) (S) (Y)	20
S220N*6	22	With Lampholder	Conic Glass		(B) (K) (M) (S) (Y)	20
S222N*	22	Bulb	Finger Proof	230V AC	(B) (K) (M) (S) (Y)	20
S222L*	22	LED	Finger Proof	230V AC	(B) (K) (M) (S) (Y)	20
S222L1*	22	LED	Finger Proof	12V AC/DC	(B) (K) (M) (S) (Y)	20
S222L2*	22	LED	Finger Proof	24V AC/DC	(B) (K) (M) (S) (Y)	20
S224N*	22	Bulb	Terminal + Screw	230V AC	(B) (K) (M) (S) (Y)	20
S224N*7	22	With Ba9S Lampholder	Terminal + Screw		(B) (K) (M) (S) (Y)	20

Please choose the colour and replace () with the letter.
Note: S1450 ve S2200 Signal Lamps are transparent.

Accessories

Code	Illumination	Features	Voltage	Colour	Box/Pcs
PDA	Bulb with Plastic Lampholder		220V AC	(B)	100
NA201Y	Neon Bulb	With Ba9S Lampholder	220V AC	(Y)	100
NA201	Neon Bulb	With Ba9S Lampholder	220V AC	(S)	100
NA101	Neon Bulb	With E10 Lampholder	220V AC	(S)	100
NA202	Filament Bulb	With Ba9S Lampholder	24V AC/DC	(S)	100



PDA



NA201Y



P1EC400E40K



M1C200E40



P1C400E72

Control Boxes



P1C300M72H



P1C400DK



P1C400E72



P1C300DY



P3EC1A2BE30



P1EC400E40K

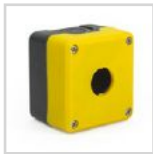

P1EBOS



P2AB



M1C200E40



PY1BOS



PK1SE



PK2



PK3



PK31S

P Series (IP65 With Suitable Buttons, Plastic Enclosed)

Code	Button Qty	Features	Box Colour	Box/Pcs
P1C300M72H	1	72 mm Mushroom Button (Black Button) (Start) (1NO)	Black-Grey	1
P1C400M72	1	72mm. Mushroom (Red Button)(Stop) (1NC)	Black-Grey	1
P1C300M72	1	72mm Mushroom (Red Button) (Start) (1NO)	Black-Grey	1
P1C400E72	1	72mm. Emergency Stop(Red Stay Put Button) (1NC)	Black-Grey	1
P1C300DY	1	Green (1NO)	Black-Grey	1
P1C400DK	1	Red (1NC)	Black-Grey	1
P1C304DK	1	Red (Start-Stop) (1NO+1NC)	Black-Grey	1
P1C304MK	1	Mushroom-Red (Start-Stop) (1NO+1NC)	Yellow-Black	1
P1EC400E40	1	Emergency Stop (1NC)	Yellow-Black	1
P1EC400E40K	1	Emergency Stop (1NC),With Plate	Yellow-Black	1
P1EC400E40L	1	Emergency Stop (1NC), With Label LED	Black-Grey	1
P2AB	2	Green-Red (Start-Stop)	Black-Grey	1
P2ABE30	2	Cylindrical Head (Start-Emergency Stop)	Black-Grey	1
P2CC	2	Green-Red (Start-Stop/Start-Stop)	Black-Grey	1
P2CCM	2	Green-Mushroom-Red (Start-Stop/Start-Stop)	Black-Grey	1
P3EC1A2BE30	3	Green-Red (Start-Stop-Emergency Stop)	Yellow-Grey	1
P43A1B	4	3 Start / 1 Stop	Black-Grey	1
P43A1BE30	4	3 Start / 1 Emergency Stop (Cyl.Head)	Black-Grey	1
P44C	4	4 Start-Stop	Black-Grey	1
P1BOS	1	Empty Box / W:68mm L:72mm H:52mm	Black-Grey	1
P1EBOS	1	Empty Box / W:68mm L:72mm H:52mm	Yellow-Black	1
P2BOS	2	Empty Box / W:68mm L:102mm H:52mm	Black-Grey	1
P3BOS	3	Empty Box / W:68mm L:132mm H:52mm	Black-Grey	1
P4BOS	4	Empty Box / W:68mm L:162mm H:52mm	Black-Grey	1
P6BOS	6	Empty Box / W:68mm L:230mm H:52mm	Black-Grey	1

NOTE:Contact blocks are mounted onto the base of the control box.

M Series (IP65 with Suitable Buttons,Metal Enclosed)

Code	Button Qty	Features	Box Colour	Box/Pcs
M1C200E40	1	Emergency Stop	Yellow-Grey	1
M1C200EE	1	Emergency Stop With Label	Yellow-Grey	1
M1CBOS	1	Empty Box / W:68mm L:72mm H:57/85mm	Yellow-Grey	1

PY Series (IP65 with available Push Buttons)

Code	Button Qty	Features	Box Colour	Box/Pcs
PY1BOS	1	Empty Box / W:68mm L:72mm H:60mm	Black-Grey	1
PY2BOS	2	Empty Box / W:68mm L:107mm H:60mm	Black-Grey	1
PY3BOS	3	Empty Box / W:68mm L:142mm H:60mm	Black-Grey	1
PY4BOS	4	Empty Box / W:68mm L:177mm H:60mm	Black-Grey	1
PY6BOS	6	Empty Box / W:68mm L:247mm H:60mm	Black-Grey	1
PY2AB	2	Start - Stop	Black-Grey	1
PY43A1B	4	3 Start - Stop	Black-Grey	1

Note: Use Selection Table for your P,PY and M Boxes Special orders. Your special orders will be delivered as individual components if the quantity is less than 50 pcs.

PK Series (IP65 with available Push Buttons)

Code	Button Qty	Features	Box Colour	Box/Pcs
PK1*	1		Black-Grey	1
PK1M*	1	With Mushroom Button	Black-Grey	1
PK1SE	1	With Emergency Stop Button	Yellow-Black	1
PK2	2		Black-Grey	1
PK3	3		Black-Grey	1
PK31S	3	With 1 Signal (S220*6)	Black-Grey	1
PK4	4		Black-Grey	1
PK5	5		Black-Grey	6
PK6	6		Black-Grey	6
PK1BOS	1	Empty Box / W:70mm L:80mm H:60mm	Black-Grey	24
PK2BOS	2	Empty Box / W: 70mm L:115mm H:60mm	Black-Grey	18
PK3BOS	3	Empty Box / W:70mm L:183mm H:60mm	Black-Grey	12
PK4BOS	4	Empty Box / W: 70mm L:183mm H:60mm	Black-Grey	12
PK5BOS	5	Empty Box / W:70mm L:260mm H:60mm	Black-Grey	6
PK6BOS	6	Empty Box / W:70mm L:260mm H:60mm	Black-Grey	6

Note: On PK Series control boxes, only KB Series buttons can be mounted.

Control Boxes Selection Table

Series	1. Hole	2. Hole	3. Hole	4. Hole	5. Hole	6. Hole	Label
PY3	56B	07C	50H	-	-	-	A

Series

- P1C** Single Hole Plastic Control Box Black-Grey
- P1EC** Single Hole Plastic Control Box Yellow-Black
- PY1** Single Hole Plastic High Control Box Black-Grey
- M1C** Single Hole Aluminium High Control Box Yellow-Grey
- P2** Two Holes Plastic Control Box Black-Grey
- PY2** Two Holes Plastic High Control Box Black-Grey
- P3** Three Holes Plastic Control Box Black-Grey
- P3EC** Three Holes Plastic Control Box Yellow-Black
- PY3** Three Holes Plastic High Control Box Black-Grey
- P4** Four Holes Plastic Control Box Black-Grey
- PY4** Four Holes Plastic High Control Box Black-Grey
- P6** Six Holes Plastic Control Box Black-Grey
- PY6** Six Holes Plastic High Control Box Black-Grey

YOU CAN CREATE YOUR SPECIAL BOX ORDER CODE FROM P BOX CODE COMBINATION TABLE NEXT PAGE

Label

- Without Label**
- A** BET08
- B** BET18
- C** BET08-Start
- D** BET08-Stop
- E** BET08-01
- F** BET08-01 OK
- G** BET08-201
- H** BET08-201 OK
- I** BET08-201 OK 2
- K** BET60P For closed boxes with single hole
- L** BET60A
- M** Special Label

Example: PY3-56B07C502H-A Code means :Box type is PY3 series, 1st Hole is push button where is 56. line and B column in the next page, 2nd Hole is push button where is 7. line and C column in the next page, 3rd Hole push button where is 50. line and H column in the next page, Label A means BET08.

Note: Use Selection Table for your P, PY and M Boxes Special orders. Your special orders will be delivered as individual components if the quantity is less than 50 pcs.

P Type Box Code Combination Table

	B BUTTON SERIES				C BUTTON SERIES				MB BUTTON SERIES				M
	A	B	C	D	E	F	G	H	I	J	K	L	
01	B100DB	B100S20	B100E	B030XB	CM100DB	CM100S20	CM100E	CM050XB	MB100DB	MB100S20	MB100E	MBSD024B	6PRPREU1MAVI
02	B100DB1	B100S21	B100E30	B030XK	CM100DB00	CM100S21	CM200E	CM060XK	MB100DB0D	MB100S21	MB102E	MBSD024K	6PRPREU1MAVIY
03	B100DB2	B100S30	B100MH	B030XM	CM100DB0Y	CM101S30	CM200EG	CM070XM	MB100DH	MB101S30	MB102MK	MBSD024M	6PRPREU1HSIYAH
04	B100DBL	B100SL20B	B100MK	B030XS	CM100DH	CM101S31	CM200MK	CM080XS	MB100DK	MB101S31	MB200E	MBSD024S	6PRPRUS1HSIYAH
05	B100DBOD	B100SL20H	B100MS	B030XY	CM100DH00	CM101S32	CM200MY	CM090XY	MB100DM	MB101S32	MB200MK	MBSD024Y	
06	B100DBOY	B100SL20K	B100MSZ	B050XB	CM100DK	CM102S30	CP100E	CM080XB	MB100DS	MB102S20	MB200EE	MBSD220B	
07	B100DBZ	B100SL20M	B100MY	B050XY	CM100DM	CM303S30	CP100M72H	CM0K0XK	MB100DY			MBSD220K	
08	B100DH	B100SL20S	B102E	B060XK	CM100DS	CP100S20	CP100MK	CM0M0XM	MB100FY			MBSD220M	
09	B100DHOD	B100SL20Y	B102E30	B070XM	CM100DY	CP100S21	CP100MY	CM0S0XS	MB100MY			MBSD220S	
10	B100DHOY	B100SL21B	B102E60	B080XS	CM101DH	CP100S30	CP101ES30	CM0Y0XY	MB101DH			MBSD220Y	
11	B100DK	B100SL21K	B102MH	B090XY	CM101DK	CP100S31	CP200E	CM0M0J20	MB101DK			MBSD220B	
12	B100DM	B100SL21Y	B102MK	B080XB	CM101DM	CP100S32	CP200E30	CM101DJ21	MB101DM			MBSD220K	
13	B100DS	B100SL30K	B102MY	B0K0XK	CM101DS	CP101S20	CP200E30	CP050XB	MB101DY			MBSD220M	
14	B100DSZ	B101S20	B200E	B0M0XM	CM101DY	CP101S21	CP200ECN	CP060XK	MB102DB			MBSD220S	
15	B100DY	B101S21	B200E30	B0S0XS	CM101K20YYOK	CP101S30	CP200ECN30	CP070XM	MB102DBOD			MBSD220Y	
16	B100DY1	B101S30	B200E60	B0Y0XY	CM102DB	CP101S31	CP200EC30	CP080XS	MB102DH			MBSD220B	
17	B100DY2	B101S31	B200EE	B100AA20	CM102DK	CP101S32	CP200EP	CP090XY	MB102DK			MBSD220K	
18	B100DYOD	B101S32	B200MH	B100AA21	CM102DM	CP102S30	CP200E30	CP0B0XB	MB102DM			MBSD220M	
19	B100DYDY	B101SL20B	B200MK	B100AC20	CM102DS	CP303S30	CP200MK	CP0K0XK	MB102DS			MBSD220S	
20	B100HB	B101SL20H	B200MS	B100AC30	CM102DY	CP304S20	CP200MY	CP0M0XM	MB102DY			MBSD220Y	
21	B100HH	B101SL20K	B200MY	B100C	CM102K20HB	CP305S30	CP200E	CP0S0XS	MB200DB			MBSD220B	
22	B100HK	B101SL20M	B202EE	B100FB	CM102K20HB10	CP100HB	CP220E	CP0Y0XY	MB200DH			MBSD220S	
23	B100HM	B101SL20S		B100FH	CM102K20HH	CP100HH	CP200EE	CP101DJ20	MB200DK			MBSD220Y	
24	B100HS	B101SL20Y		B100FK	CM102K20KY	CP100HK		CP101DJ21	MB200DM			MBSD220B	
25	B100HY	B101SL30B		B100FM	CM102K21HB	CP100HM		CM101A31	MB200DS			MBSD220K	
26	B101DBOD	B101SL30K		B100FS	CM102K21KY	CP100HS		CM100A20	MB200DY			MBSD220M	
27	B101DH	B101SL30M		B100FY	CM200DHO	CP100HY		CM100A21	MB200FK			MBSD220S	
28	B101DM	B101SL30S		B101AA30	CM200DK	CP101HY		CM100A30	MB202DK				
29	B101DY	B101SL30Y		B101AA32	CM200DY	CP102HB		CM101A20					
30	B101DYOD	B101SL31K		B101AC30	CM202DK	CP102ZH		CM101A21					
31	B101HY	B101SL31Y		B101K20BB12	CM305DY	CP102HK		CM101A30					
32	B102DB	B101SL32B		B101K20HB	CP100DB	CP102HM		CP200AC20					
33	B102DBOD	B101SL32K		B101K20HH	CP100BOD	CP102HS		CP102AA20					
34	B102DH	B101SL32S		B101K20HHOK	CP100BOY	CP102HY		CP102AA30					
35	B102DK	B101SL32Y		B101K20SS12	CP100DH	CP200HK		CP102AC30					
36	B102DM	B101T20		B101K20YY12	CP100HOD	CP200HY		CP101AA20					
37	B102DS	B101T201		B101K20YYOK	CP100H0Y	CP202HK		CP101AA30					
38	B102DY	B102S20		B102AA20	CP100DK	CP230HK		CP101AC20					
39	B102HB	B102S30		B102AA30	CP100DM			CP101AC30					
40	B102HH	B102S32		B102AC20	CP100DS			CP100AA20					
41	B102HK	B102SL20K		B102AC30	CP100DY			CP100AC20					
42	B102HM	B102SL20Y		B102C	CP101DK			CP100AC30					
43	B102HS	B102SL32Y		B102K20HB	CP101DY			CM102A20					
44	B102HY	B102T20		B102K20KY	CP101K20HB			CM102A21					
45	B130DB	B111S20		B102K20KY10	CP102DB			CM102A30					
46	B130DH	B121R30		B102K20SH	CP102DH			CM102A31					
47	B130DK	B121R301		B102K20SH10	CP102DK			CM100HB					
48	B130DM	B130SL20B		B102K20SYH10	CP102DM			CM100HH					
49	B130DS	B130SL20K		B102K21HB	CP102DS			CM100HK					
50	B130DY	B130SL20M		B102K21KY	CP102DY			CM100HM					
51	B130HY	B130SL20S		B132K20HB	CP102K20HB			CM100HS					
52	B131DY	B130SL20Y		B132K20KY	CP102K20HS			CM100HY					
53	B132DK	B130SL21B		B132K21HB	CP102K20KY			CM101HY					
54	B132DS	B130SL21K		B132K21KY	CP102K21HB			CM102HB					
55	B132DY	B130SL21Y		B151K20HHOK	CP102K21KY			CM102HH					
56	B170DM	B131SL20K		B191K20HBS	CP200DB			CM102HK					
57	B180DS	B131SL20S		B192K21HB	CP200DK			CM102HM					
58	B190DY	B131SL20Y		B200C	CP200DM			CM102HS					
59	B200DH	B131SL30B		B102K20HSLZ	CP200DS			CM102HY					
60	B200DHO	B131SL30K			CP200DY			CM200HK					
61	B200DK	B131SL30M			CP202DK			CM200HY					
62	B200DKO	B131SL30S			CP303DY			CM202HK					
63	B200DM	B131SL30Y			CP305DY			CM230HK					
64	B200DSL	B131SL31B			CP101K20YYOK								
65	B200DSZ	B131SL31K											
66	B200DY	B131SL31Y											
67	B200FK	B131SL32B											
68	B200HK	B131SL32K											
69	B200HY	B131SL32Y											
70	B202DK	B132SL30B											
71	B202HK	B132SL30K											
72	B230DK	B132SL30M											
73	B230DY	B132SL30S											
74	B230HK	B132SL30Y											
75	B232DK	B132SL32K											
76	B232DY	B132SL32Y											
77	B100DHL	B160SL20K											
78		B161SL30K											
79		B180SL20S											
80		B190SL20Y											
81		B191SL30Y											
82		B191SL32Y											
83		B1K1SL30K											
84		B1S1SL30S											
85		B1Y1SL30Y											
86		B1Y1SL32Y											



PDNS11BX10



PDKS11GX23G



PDKA22BG33O

Foot Switches



PDP1



PDM11



PDA2



PPKS11BX10



PDKS11BX10



PDKS11VX20



PDNS11BX10



PDKS11BX10T



PDKS11GX23G



PDKA22GG10G



PDKA22GG10



PDKA22BG330

Plastic Series

Code	Type	Contact Block	Colour	Box/Pcs
PDM1	Mini	1 CO	●	10
PDM11	Mini, Cable (1m.)	1 CO	●	1
PDP1	Midi	1 NO	●	1
PDP2	Midi	2 NO	●	1

Aluminium Series

Code	Type	Contact Block	Colour	Box/Pcs
PDA1	Midi	1 NO	●	1
PDA2	Midi	2 NO	●	1

Foot Protection Series

Single Foot Switch

Code	Material	Metal Bar Mountable	Contact Block	Speed	With Protection	Box/Pcs
PDNS11BX10	Plastic		1 NO + 1 NC			1
PPKS11BX10	Plastic		1 NO + 1 NC		✓	1
PDKS11BX10*	Aluminium		1 NO + 1 NC		✓	1
PDKS11BX11*	Aluminium		1 NO + 1 NC	Stay Put	✓	1
PDKS11GX10*	Aluminium		2x(1 NO + 1 NC)		✓	1
PDKS11GX12*	Aluminium		2x(1 NO + 1 NC)	With Reset	✓	1
PDKS11GX20*	Aluminium		2x(1 NO + 1 NC)	Double	✓	1
PDKS11UX20*	Aluminium		(1 NO + 1 NC) + 2x(1 NO + 1 NC)	Double	✓	1
PDKS11VX20*	Aluminium		2x(1NO + 1NC) + 2x(1 NO + 1NC)	Double	✓	1
PDKA11BX10*	Aluminium	✓	1 NO + 1 NC		✓	1
PDKA11GX10*	Aluminium	✓	2x(1 NO + 1 NC)		✓	1
PDKA11GX20*	Aluminium	✓	2x(1 NO + 1 NC)	Double	✓	1
PDKS11GX23	Aluminium		(1 NO + 1 NC) + 2 NC	With Reset and Double	✓	1

Potentiometer

Code	Material	Metal Bar Mountable	Contact Block	Features	With Protection	Box/Pcs
PDKS11PX10	Aluminium		1 CO	10 k Ω	✓	1

* Please replace (*) with the letter T for orange, G for grey. Note: BX11 is Stay-Put Type.

Double Foot Switch

Code	Material	Metal Bar Mountable	Contact Block	Speed	With Protection	Box/Pcs
PDKA22BB10	Aluminium	✓	(1NO+1NC) + (1NO+1NC)		✓	1
PDKA22BG10	Aluminium	✓	(1NO+1NC) + 2x (1 NO+1NC)		✓	1
PDKA22BG20	Aluminium	✓	(1NO+1NC) + 2x (1NO+1NC)	Double	✓	1
PDKA22BG330	Aluminium	✓	(1NO+1NC) + ((1NO+1NC) + 2NC)	Normal + With Reset and Double	✓	1
PDKA22GG10	Aluminium	✓	2x (1NO+1NC) + 2x (1NO+1NC)		✓	1
PDKA22GG20	Aluminium	✓	2x (1NO+1NC) + 2x (1NO+1NC)	Double	✓	1
PDKA22GG10G	Aluminium	✓	2x (1NO+1NC) + 2x (1NO+1NC)		✓	1

Accessories

Code	Type	With Emergency	Box/Pcs
PDABE	Metal Bar	✓	1
PDABT	Metal Bar		1

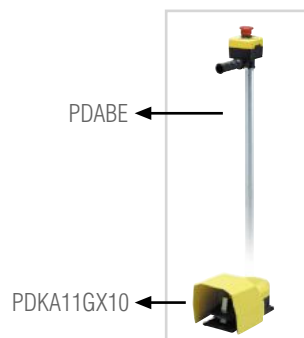
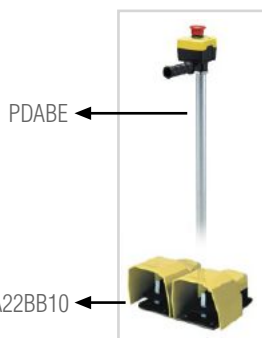



L53K13MIP211

L5K13MEL123A



L51K13MEP123



L52K23HUM112



L54K16MUM331



L61K13PUM211

Limit Switches



L1K13MEM121



L1K13MIM111



L1K13MEL121



L1K13PUM211



L1K13MIM311



L1K13MIP111



L1K13MUM331



L1K13ROP101



L2K13MIM311



L2K13MEP123



L2K13SOP102



L2K13SOM101



L2K13MEL121



L2K13MEM121



L2K23PUM211



L2K13MIM211

L1 Series, Aluminium Body, Snap Action, IP 65 (except MIP11, MIM11)

Code	Actuator	Actuator Type	Actuator End Unit Material
L1K13MIP111*	Angular Action Roller One Way	Metal	Plastic
L1K13MIM111*	Angular Action Roller One Way	Metal	Metal
L1K13MIP211*	Angular Action Roller One Way	Aluminium	Plastic
L1K13MIM211*	Angular Action Roller One Way	Aluminium	Metal
L1K13MIP311*	Angular Action Roller One Way	Plastic	Plastic
L1K13MIM311*	Angular Action Roller One Way	Plastic	Metal
L1K13MEP121*	Angular Action Roller Two Way	Plastic	Plastic
L1K13MEM121*	Angular Action Roller Two Way	Plastic	Metal
L1K13MEL121*	Angular Action Roller Two Way	Plastic	Rubber
L1K13PUM211*	Plunger	Plastic	Metal
L1K13MUM331*	Linear Roller	Plastic	Metal
L1K13SOM101	Spiral Lever	Plastic	Metal
L1K13SOM102	Spiral Arm	Plastic	Metal
L1K13ROP101*	Rigid Rod	Plastic	Plastic
L1K13SOP101	Spiral Arm	Plastic	Plastic-Metal
L1K13SOP102	Spiral Arm	Plastic	Plastic-Metal
L1K13SOP103	Spiral Arm	Plastic	Plastic-Metal

L2 Series, Aluminium Body, Plastic Cover, Snap Action, IP 65

Code	Actuator	Actuator Type	Actuator End Unit Material
L2K13MIP211*	Angular Action Roller One Way	Metal	Plastic
L2K13MIM211*	Angular Action Roller One Way	Metal	Metal
L2K13MIP311*	Angular Action Roller One Way	Plastic	Plastic
L2K13MIM311*	Angular Action Roller One Way	Plastic	Metal
L2K13MEP121*	Angular Action Roller Two Way	Plastic	Plastic
L2K13MEP122	Angular Action Roller Two Way, Adjustable	Plastic	Plastic
L2K13MEP123*	Angular Action Roller Two Way, Adjustable	Plastic	Plastic
L2K13MEP124*	Angular Action Roller Two Way, Adjustable	Plastic	Plastic
L2K13MEL121*	Angular Action Roller Two Way, Adjustable	Plastic	Rubber
L2K13MEM121*	Angular Action Roller Two Way	Plastic	Metal
L2K13MEM122	Angular Action Roller Two Way, Adjustable	Plastic	Metal
L2K13MEM123*	Angular Action Roller Two Way, Adjustable	Plastic	Metal
L2K13MEM124*	Angular Action Roller Two Way	Plastic	Metal
L2K13PUM211*	Plunger	Plastic	Metal
L2K13MUM331*	Linear Roller	Plastic	Metal
L2K13SOM101	Spiral Lever	Plastic	Metal
L2K13SOM102	Spiral Arm	Plastic	Metal
L2K13ROP101*	Rigid Rod	Plastic	Plastic
L2K13SOP101	Spiral Arm	Plastic	Plastic-Metal
L2K13SOP102	Spiral Arm	Plastic	Plastic-Metal
L2K13SOP103	Spiral Arm	Plastic	Plastic-Metal



L3K13MIM411



L3K13MEP124



L3K13MUM331



L3K13REF121



L3K13MIP311



L3K13MEM121



L3K13MEL122



L3K13MEM124



L3K13PUM211



L3K13ROP101

L3 Series, Plastic Body, Snap Action, IP 65

Code	Actuator	Actuator Type	Actuator End Unit Material
L3K13MIP311*	Angular Action Roller One Way	Plastic	Plastic
L3K13MIP411*	Angular Action Roller One Way	Plastic	Plastic
L3K13MIM311*	Angular Action Roller One Way	Plastic	Metal
L3K13MIM411*	Angular Action Roller One Way	Plastic	Metal
L3K13MEP121*	Angular Action Roller Two Way	Plastic	Plastic
L3K13MEP122	Angular Action Roller Two Way, Adjustable	Plastic	Plastic
L3K13MEP123*	Angular Action Roller Two Way, Adjustable	Plastic	Plastic
L3K13MEP124*	Angular Action Roller Two Way, Adjustable	Plastic	Plastic
L3K13MEM121*	Angular Action Roller Two Way, Adjustable	Plastic	Metal
L3K13MEM122	Angular Action Roller Two Way, Adjustable	Plastic	Metal
L3K13MEM123*	Angular Action Roller Two Way, Adjustable	Plastic	Metal
L3K13MEM124*	Angular Action Roller Two Way, Adjustable	Plastic	Metal
L3K13MEL121*	Angular Action Roller Two Way, Adjustable	Plastic	Rubber
L3K13MEL122	Angular Action Roller Two Way, Adjustable	Plastic	Rubber
L3K13PUM211*	Plunger	Plastic	Metal
L3K13MUM331*	Linear Roller	Plastic	Metal
L3K13SOM101	Spiral Lever	Plastic	Metal
L3K13SOM102	Spiral Arm	Plastic	Metal
L3K13ROP101*	Rigid Rod	Plastic	Plastic
L3K13SOP101	Spiral Arm	Plastic	Plastic-Metal
L3K13SOP102	Spiral Arm	Plastic	Plastic-Metal
L3K13SOP103	Spiral Arm	Plastic	Plastic-Metal
L3K13REM121*	Metal Arm	Plastic	Metal
L3K13REF121	Fiber Arm	Plastic	Fiber

* Positive opening Function

Note : For contact block alternatives, please see contact blocks table on Page 36



L4K16MIM311



L4K16MEP121

L4 Series, Aluminium Body, Double Contact Block, Snap Action, IP 65 (Except MIP111, MIM111)

Code	Actuator	Actuator Type	Actuator End Unit Material
L4K16MIM111	Angular Action Roller One Way	Metal	Metal
L4K16MIP111	Angular Action Roller One Way	Metal	Plastic
L4K16MIP211	Angular Action Roller One Way	Metal	Plastic
L4K16MIM211	Angular Action Roller One Way	Metal	Metal
L4K16MIP311	Angular Action Roller One Way	Plastic	Plastic
L4K16MIM311	Angular Action Roller One Way	Plastic	Metal
L4K16MEP121	Angular Action Roller Two Way	Plastic	Plastic
L4K16MEM121	Angular Action Roller Two Way	Plastic	Metal
L4K16PUM211	Plunger	Plastic	Metal
L4K16MUM331	Linear Roller	Plastic	Metal



L5K13MIP311



L5K13MIP411



L5K13MEP123



L5K13MEP124



L5K13MUM331



L5K13MUM332R



L5K13MIP211



L5K13MEL121



L5K13MEM121



L5K13MIP411R



L5K23LEM411



L5K23BEM621



L5K23CPDE



L5K23LUM323



L5K23LUM321



L5K23LUM322

L5 Series, Plastic Body, Snap Action, IP 65

Code	Actuator	Actuator Type	Actuator End Unit Material
L5K13MIP211*	Angular Action Roller One Way (22mm)	Plastic	Plastic
L5K13MIP311*	Angular Action Roller One Way	Plastic	Plastic
L5K13MIM311R	Angular Action Roller One Way, Adjustable	Plastic	Metal
L5K13MIP411*	Angular Action Roller One Way	Plastic	Plastic
L5K13MIP411R*	Angular Action Roller One Way, with Reset	Plastic	Plastic
L5K13MIM211*	Angular Action Roller One Way (22mm)	Plastic	Metal
L5K13MIM311*	Angular Action Roller One Way	Plastic	Metal
L5K13MIM411*	Angular Action Roller One Way	Plastic	Metal
L5K13MIM411R	Angular Action Roller One Way, Adjustable	Plastic	Metal
L5K13MEP121*	Angular Action Roller Two Way	Plastic	Plastic
L5K13MEP122*	Angular Action Roller Two Way, Adjustable	Plastic	Plastic
L5K13MEP123*	Angular Action Roller Two Way, Adjustable	Plastic	Plastic
L5K13MEP124*	Angular Action Roller Two Way, Adjustable	Plastic	Plastic
L5K13MEM121*	Angular Action Roller Two Way	Plastic	Metal
L5K13MEM122*	Angular Action Roller Two Way, Adjustable	Plastic	Metal
L5K13MEM123*	Angular Action Roller Two Way, Adjustable	Plastic	Metal
L5K13MEL121*	Angular Action Roller Two Way	Plastic	Rubber
L5K13MEL122*	Angular Action Roller Two Way, Adjustable	Plastic	Rubber
L5K13MEL123*	Angular Action Roller Two Way, Adjustable	Plastic	Rubber
L5K13MEL123A*	Angular Action Roller Two Way, Adjustable	Plastic	Rubber
L5K13MEM124*	Angular Action Roller Two Way, Adjustable	Plastic	Metal
L5K13PUM211*	Plunger	Plastic	Metal
L5K13PUM211R*	Plunger, with Reset	Plastic	Metal
L5K13PUP211	Plunger	Plastic	Plastic
L5K13MUM331*	Linear Roller	Plastic	Metal
L5K13MUM331R*	Linear Roller, with Reset	Plastic	Metal
L5K13MUM332R*	Linear Roller, with Reset	Plastic	Metal
L5K13SOM101	Spiral Lever	Plastic	Metal
L5K13SOM102	Spiral Arm	Plastic	Metal
L5K13SOM103	Spiral Arm	Plastic	Metal
L5K13SOP101	Spiral Arm	Plastic	Plastic-Metal
L5K13SOP102	Spiral Arm	Plastic	Plastic-Metal
L5K13SOP103	Spiral Arm	Plastic	Plastic-Metal
L5K13ROP101*	Rigid Rod	Plastic	Plastic
L5K13CPDE	Emergency Stop	Plastic	Plastic
L5K13REM121	Fiber Arm	Plastic	Metal
L5K13REF121	Fiber Arm	Plastic	Fiber

L5 Series, Plastic Body, Slow Action, IP 65

Code	Actuator	Actuator Type	Actuator End Unit Material
L5K23MEL123A	Angular Action Roller Two Way, Adjustable	Plastic	Rubber
L5K23SOM103	Spiral Arm	Plastic	Metal
L5K23LEM411*	Hinge	Plastic	Metal
L5K23LEM412*	Hinge	Plastic	Metal
L5K23LEM511*	Hinge	Plastic	Metal
L5K23LEM621*	Hinge	Plastic	Metal
L5K23LEM622*	Hinge	Plastic	Metal
L5K23BEM621*	Rotational Tube	Plastic	Metal
L5K23LUM321*	Curved Key	Plastic	Metal
L5K23LUM322*	Straight Key	Plastic	Metal
L5K23LUM323	Movable Key	Plastic	Metal
L5K23MUM332R*	Linear Roller, with Reset	Plastic	Metal
L5K23CPDE	Emergency Stop	Plastic	Plastic
L5K23LUM324	Movable Key	Plastic	Metal

* Positive opening Function

Note : For contact block alternatives, please see contact blocks table on Page 36



L51K13MIM311



L51K13MIP211



L51K13MEM121



L51K13MIM411



L51K13SOM101



L51K13MEM122



L51K13MEL122



L51K13SOM102



L51K13MUM331



L51K13MEM124



L51K13REF121



L51K13ROP101



L51K23HUM112



L51K23LUM321



L51K23LUM322



L51K23LUM323

L51 Series, Metal Body, Snap Action, IP 65

Code	Actuator	Actuator Type	Actuator End Unit Material
L51K13MIP211	Angular Action Roller One Way	Metal	Plastic
L51K13MIP311*	Angular Action Roller One Way	Metal	Plastic
L51K13MIP411	Angular Action Roller One Way	Metal	Plastic
L51K13MIM211	Angular Action Roller One Way	Metal	Metal
L51K13MIM311*	Angular Action Roller One Way	Metal	Metal
L51K13MIM411*	Angular Action Roller One Way	Metal	Metal
L51K13MEP121*	Angular Action Roller Two Way	Metal	Plastic
L51K13MEP122*	Angular Action Roller Two Way, Adjustable	Metal	Plastic
L51K13MEP123*	Angular Action Roller Two Way, Adjustable	Metal	Plastic
L51K13MEP124*	Angular Action Roller Two Way, Adjustable	Metal	Plastic
L51K13MEP125*	Angular Action Roller Two Way	Metal	Plastic-Metal
L51K13MEM121*	Angular Action Roller Two Way	Metal	Metal
L51K13MEM122*	Angular Action Roller Two Way, Adjustable	Metal	Metal
L51K13MEM123*	Angular Action Roller Two Way, Adjustable	Metal	Metal
L51K13MEL121*	Angular Action Roller Two Way	Metal	Rubber
L51K13MEL122*	Angular Action Roller Two Way, Adjustable	Metal	Rubber
L51K13MEL123*	Angular Action Roller Two Way, Adjustable	Metal	Rubber
L51K13MEL123A*	Angular Action Roller Two Way, Adjustable	Metal	Rubber
L51K13MEM124*	Angular Action Roller Two Way, Adjustable	Metal	Plastic-Metal
L51K13MEM125*	Angular Action Roller Two Way	Metal	Metal
L51K13PUM211*	Plunger	Metal	Plastic-Metal
L51K13MUM331*	Linear Roller	Metal	Plastic-Metal
L51K13MUM331F	Linear Roller, Stay Put	Metal	Plastic-Metal
L51K13SOM101	Spiral Lever	Metal	Plastic-Metal
L51K13SOM102	Spiral Arm	Metal	Plastic-Metal
L51K13SOM103	Spiral Arm	Metal	Metal
L51K13SOP101	Spiral Arm	Metal	Plastic-Metal
L51K13SOP102	Spiral Arm	Metal	Plastic-Metal
L51K13SOP103	Spiral Arm	Metal	Plastic-Metal
L51K13ROP101*	Rigid Rod	Metal	Plastic
L51K13REF121	Rigid Rod	Metal	Fiber
L51K13REM121*	Rigid Rod	Metal	Metal
L51K13LEM411	Hinge	Metal	Metal
L51K13LEM412	Hinge	Metal	Metal
L51K13LEM511	Hinge	Metal	Metal
L51K13LEM621	Hinge	Metal	Metal
L51K13LEM622	Hinge	Metal	Metal

L51 Series, Metal Body, Slow Action, IP 65

Code	Actuator	Actuator Type	Actuator End Unit Material
L51K23LUM321*	Curved Key	Metal	Metal
L51K23LUM322*	Straight Key	Metal	Metal
L51K23LUM323	Movable Key	Metal	Metal
L51K23LUM324	Movable Key	Metal	Metal
L51K23HUM111	Metal Ring	Metal	Metal
L51K23HUM112	Metal Ring, with Reset	Metal	Metal

Note: Maximum usable wire length is 12 metre for L51K23HUM111 and L51K23HUM112 limit switches



L52K13MIM311



L52K13MIM411



L52K13MEP123



L52K13MEP124



L52K13MUM331



L52K13PUM211



L52K13REF121



L52K13REM121



L52K13MEL122



L52K13MIP211



L52K13MEL123



L52K13MEP121

L52 Series, Metal Body, Snap Action, IP 65

Code	Actuator	Actuator Type	Actuator End Unit Material
L52K13MIP211	Angular Action Roller One Way	Metal	Plastic
L52K13MIP311*	Angular Action Roller One Way	Metal	Plastic
L52K13MIP411*	Angular Action Roller One Way	Metal	Plastic
L52K13MIM211	Angular Action Roller One Way	Metal	Metal
L52K13MIM311*	Angular Action Roller One Way	Metal	Metal
L52K13MIM411*	Angular Action Roller One Way	Metal	Metal
L52K13MEP121*	Angular Action Roller Two Way	Metal	Plastic
L52K13MEP122*	Angular Action Roller Two Way, Adjustable.	Metal	Plastic
L52K13MEP123*	Angular Action Roller Two Way, Adjustable.	Metal	Plastic
L52K13MEP124*	Angular Action Roller Two Way, Adjustable.	Metal	Plastic
L52K13MEP125*	Angular Action Roller Two Way	Metal	Plastic-Metal
L52K13MEM121*	Angular Action Roller Two Way	Metal	Metal
L52K13MEM122*	Angular Action Roller Two Way, Adjustable.	Metal	Metal
L52K13MEM123*	Angular Action Roller Two Way, Adjustable.	Metal	Metal
L52K13MEL121*	Angular Action Roller Two Way, Adjustable.	Metal	Rubber
L52K13MEL122*	Angular Action Roller Two Way	Metal	Rubber
L52K13MEL123*	Angular Action Roller Two Way, Adjustable.	Metal	Rubber
L52K13MEL123A*	Angular Action Roller Two Way, Adjustable.	Metal	Rubber
L52K13MEM124*	Angular Action Roller Two Way, Adjustable.	Metal	Metal
L52K13PUM211*	Plunger	Metal	Metal
L52K13MUM331*	Linear Roller	Metal	Metal
L52K13MUP331	Linear Roller	Metal	Plastic
L52K13SOM101	Spiral Lever	Metal	Metal
L52K13SOM102	Spiral Arm	Metal	Metal
L52K13SOM103	Spiral Arm	Metal	Metal
L52K13SOP101	Spiral Arm	Metal	Plastic-Metal
L52K13SOP102	Spiral Arm	Metal	Plastic-Metal
L52K13SOP103	Spiral Arm	Metal	Plastic-Metal
L52K13ROP101*	Rigid Rod	Metal	Plastic
L52K13REF121	Rigid Rod	Metal	Fiber
L52K13REM121*	Rigid Rod	Metal	Metal
L52K13LEM411	Hinge	Metal	Metal
L52K13LEM412	Hinge	Metal	Metal
L52K13LEM511	Hinge	Metal	Metal
L52K13LEM621	Hinge	Metal	Metal
L52K13LEM622	Hinge	Metal	Metal

* Positive opening Function

Note : For contact block alternatives, please see contact blocks table on Page 36



L52K23LUM322



L52K23HUM112



L52K23LUM323



L52K23LUM324

L52 Series, Metal Body, Slow Action

Code	Actuator	Actuator Type	Actuator End Unit Material
L52K23LUM321*	Curved Key	Metal	Metal
L52K23LUM322*	Straight Key	Metal	Metal
L52K23LUM323	Movable Key	Metal	Metal
L52K23LUM324	Movable Key	Metal	Metal
L52K23HUM111	Metal Ring	Metal	Metal
L52K23HUM112	Metal Ring, with Reset	Metal	Metal

* Positive opening Function

Note: Maximum usable wire length is 12 metre for L52K23HUM111 and L52K23HUM112 limit switches



L53K13MIM31



L53K13MIP211



L53K13MEL123



L53K13MEP125



L53K13PUM211



L53K13MEL123A



L53K13MEM121



L53K13MUM331



L53K13SOM102



L53K13SOP103



L53K23LEM621



L53K13MEM124

L53 Series, Metal Body, Heavy Duty with 3 Cable Entry, Snap Action, IP 65

Code	Actuator	Actuator Type	Actuator End Unit Material
L53K13MIP211	Angular Action Roller One Way	Metal	Plastic
L53K13MIP311*	Angular Action Roller One Way	Metal	Plastic
L53K13MIP411*	Angular Action Roller One Way	Metal	Plastic
L53K13MIM211	Angular Action Roller (22 mm)	Metal	Metal
L53K13MIM311*	Angular Action Roller One Way	Metal	Metal
L53K13MEP121*	Angular Action Roller Two Way	Metal	Plastic
L53K13MEP122*	Angular Action Roller Two Way, Adjustable.	Metal	Plastic
L53K13MEP123*	Angular Action Roller Two Way, Adjustable.	Metal	Plastic
L53K13MEP124*	Angular Action Roller Two Way, Adjustable.	Metal	Plastic
L53K13MEP125*	Angular Action Roller Two Way, Adjustable.	Metal	Plastic
L53K13MEM121*	Angular Action Roller Two Way	Metal	Metal
L53K13MEM122*	Angular Action Roller Two Way, Adjustable.	Metal	Metal
L53K13MEM123*	Angular Action Roller Two Way, Adjustable.	Metal	Metal
L53K13MEL121*	Angular Action Roller Two Way	Metal	Rubber
L53K13MEL122*	Angular Action Roller Two Way, Adjustable.	Metal	Rubber
L53K13MEL123*	Angular Action Roller Two Way, Adjustable.	Metal	Rubber
L53K13MEL123A*	Angular Action Roller Two Way, Adjustable.	Metal	Rubber
L53K13MEM124*	Angular Action Roller Two Way, Adjustable.	Metal	Metal
L53K13MEM125*	Angular Action Roller Two Way	Metal	Metal
L53K13PUM211*	Plunger	Metal	Metal
L53K13MUM331*	Linear Roller	Metal	Metal
L53K13MUP331	Linear Roller	Metal	Plastic
L53K13SOM101	Spiral Lever	Metal	Metal
L53K13SOM102	Spiral Arm	Metal	Metal
L53K13SOM103	Spiral Arm	Metal	Metal
L53K13SOP101	Spiral Arm	Metal	Plastic-Metal
L53K13SOP102	Spiral Arm	Metal	Plastic-Metal
L53K13SOP103	Spiral Arm	Metal	Plastic-Metal
L53K13ROP101*	Rigid Rod	Metal	Plastic
L53K13REF121	Rigid Rod	Metal	Fiber
L53K13REM121	Fiber Arm	Metal	Metal
L53K13LEM411	Hinge	Metal	Metal
L53K13LEM412	Hinge	Metal	Metal
L53K13LEM511	Hinge	Metal	Metal
L53K13LEM621	Hinge	Metal	Metal
L53K13LEM622	Hinge	Metal	Metal

Note : For contact block alternatives, please see contact blocks table on Page 36



L53K23LUM321



L53K23LUM322



L53K23LUM321



L53K23LUM323

L53 Series, Metal Body, Heavy Duty With 3 Cable Entry, Slow Action, IP 65

Code	Actuator	Actuator Type	Actuator End Unit Material
L53K23LUM321	Curved Key	Metal	Metal
L53K23LUM322	Straight Key	Metal	Metal
L53K23HUM111	Metal Ring	Metal	Metal
L53K23HUM112	Metal Ring, with Reset	Metal	Metal

Note: Maximum usable wire length is 12 metre for L53K23HUM111 and L53K23HUM112 limit switches



L54K16MIP211



L54K16MIM211



L54K16MIP311



L54K16MIM311



L54K16MEP121



L54K16MEM121



L54K16MEM122



L54K16MEP124



L54K16MEM123



L54K16MEM124



L54K16PUM211



L54K16MEL121



L54K16MEL123



L54K16MEP122



L54K16MUM331

L54 Series, Snap and Slow Action, IP65

Code	Actuator	Actuator Type	Actuator End Unit Material
L54K16MIP211	Angular Action Roller One Way	Metal	Plastic
L54K16MIM211	Angular Action Roller One Way	Metal	Metal
L54K16MIP311	Angular Action Roller One Way	Metal	Plastic
L54K16MIM311	Angular Action Roller One Way	Metal	Metal
L54K16MEP121	Angular Action Roller Two Way	Metal	Plastic
L54K16MEM121	Angular Action Roller Two Way	Metal	Metal
L54K16MEP122	Angular Action Roller Two Way, Adjustable	Metal	Plastic
L54K16MEM122	Angular Action Roller Two Way, Adjustable	Metal	Metal
L54K16MEP123	Angular Action Roller Two Way, Adjustable	Metal	Plastic
L54K16MEM123	Angular Action Roller Two Way, Adjustable	Metal	Metal
L54K16MEP124	Angular Action Roller Two Way, Adjustable	Metal	Plastic
L54K16MEM124	Angular Action Roller Two Way, Adjustable	Metal	Metal
L54K16MEL121	Angular Action Roller Two Way	Metal	Rubber
L54K16MEL122	Angular Action Roller Two Way	Metal	Rubber
L54K16MEL123	Angular Action Roller Two Way, Adjustable	Metal	Rubber
L54K16PUM211	Plunger	Metal	Metal
L54K16MUM331	Linear Roller	Metal	Metal



L61K13PUM211



L61K13MUM331



L61K13MEM121



L61K13MEP121

L61 Series, Metal Body, With Cable, IP67, Snap Action (2 mt.cable)

Code	Actuator	Actuator Type	Actuator End Unit Material
L61K13MUM331*	Linear Roller	Metal	Metal
L61K13PUM211*	Plunger	Metal	Metal
L61K13MEM121*	Angular Action Roller Two Way	Metal	Metal
L61K13MEP121*	Angular Action Roller Two Way	Metal	Plastic
L61K13MIM311*	Angular Action Roller One Way	Metal	Metal
L61K13MIP311*	Angular Action Roller One Way	Metal	Plastic



L66K13MUM331



L66K13MEP121



L66K13PUM211



L66K13MEM121

L66 Series, Plastic Body, With Cable, IP67, Snap Action (2 mt.cable)

Code	Actuator	Actuator Type	Actuator End Unit Material
L66K13MUM331*	Linear Roller	Metal	Metal
L66K13PUM211*	Plunger	Metal	Metal
L66K13MEM121*	Angular Action Roller Two Way	Plastic	Metal
L66K13MEP121*	Angular Action Roller Two Way	Plastic	Plastic
L66K13MIM311*	Angular Action Roller One Way	Plastic	Metal
L66K13MIP311*	Angular Action Roller One Way	Plastic	Plastic

* Positive opening Function

Spare Parts of Limit Switches

Actuator

Code	Body Type	Actuator Type	End Unit Material	Features	Box/Pcs
LD11MIP111	L1,L4	Angular Action Roller One Way	Plastic	Metal Sheet Construction	20
LD11MIM111	L1,L4	Angular Action Roller One Way	Metal	Metal Sheet Construction	20
LD22MIP211	L1,L2,L4	Angular Action Roller One Way	Plastic	Metal Construction	20
LD22MIM211	L1,L2,L4	Angular Action Roller One Way	Metal	Metal Construction	20
LD23MIP311	L1,L2,L3,L4	Angular Action Roller One Way	Plastic	Plastic Construction	20
LD23MIM311	L1,L2,L3,L4	Angular Action Roller One Way	Metal	Plastic Construction	20
LD23MIP411	L3	Angular Action Roller One Way	Plastic	Plastic Construction with Angle	20
LD23MIM411	L3	Angular Action Roller One Way	Metal	Plastic Construction with Angle	20
LD23MEP121	L1,L2,L3,L4	Angular Action Roller Two Way	Plastic	Plastic Construction - Rotating Arm	20
LD23MEM121	L1,L2,L3,L4	Angular Action Roller Two Way	Metal	Plastic Construction - Rotating Arm	20
LD23PUM211	L1,L2,L3,L4	Plunger	Metal	Plastic Construction	20
LD23MUM331	L1,L2,L3,L4	Linear Roller	Metal	Plastic Construction	20
LD23SOM101	L1,L2,L3	Spiral Lever	Metal	Plastic Construction - Multi Way	20
LD23SOM102	L1,L2,L3	Spiral Arm	Metal	Plastic Construction - Multi Way	20
LD23SOP101	L1,L2,L3	Spiral Arm	Plastic	Plastic Construction - Multi Way	20
LD23SOP102	L1,L2,L3	Spiral Arm	Plastic	Plastic Construction - Multi Way	20
LD23SOP103	L1,L2,L3	Spiral Arm	Plastic	Plastic Construction - Multi Way	20
LD23ROP101	L1,L2,L3	Rigid Rod	Plastic	Plastic Construction - Multi Way	20
LD23MEL121	L1,L2,L3	Angular Action Roller Two Way	Rubber	Plastic Construction - Rotating Arm	20
LD23MEP123	L2,L3	Angular Action Roller Two Way	Plastic	Plastic Construction - Rotating Arm	20
LD23MEM123	L2,L3	Angular Action Roller Two Way	Metal	Plastic Construction - Rotating Arm	20
LD33MIM311	L5	Angular Action Roller One Way	Metal	Plastic Construction with Angle	20
LD33MIP311	L5	Angular Action Roller One Way	Plastic	Plastic Construction with Angle	20
LD33MIP411	L5	Angular Action Roller One Way	Plastic	Plastic Construction with Angle	20
LD33MEP121	L5	Angular Action Roller Two Way	Plastic	Plastic Construction - Rotating Arm	20
LD33MEP122	L5	Angular Action Roller Two Way	Plastic	Plastic Construction - Rotating Arm	20
LD33MEP123	L5	Angular Action Roller Two Way	Plastic	Plastic Construction - Rotating Arm	20
LD33MEM122	L5	Angular Action Roller Two Way	Metal	Plastic Construction - Rotating Arm	20
LD33MEL121	L5	Angular Action Roller Two Way	Rubber	Plastic Construction - Rotating Arm	20
LD33MEL122	L5	Angular Action Roller Two Way	Rubber	Plastic Construction - Rotating Arm	20
LD33MEL123	L5	Angular Action Roller Two Way	Rubber	Plastic Construction - Rotating Arm	20
LD33MEL124	L5	Angular Action Roller Two Way	Rubber	Plastic Construction - Rotating Arm	20
LD33MUP331	L5	Linear Roller	Plastic	Plastic Construction	20
LD33MUM331	L5	Linear Roller	Metal	Plastic Construction	20
LD33CPDE	L5	Emergency Stop	Plastic	Plastic Construction	20
LD33CPA	L5	Button Adapter	-	-	20
LA33LUM320	L5,L51,L52,L53	Straight Key	Metal	-	20
LA33LUM321	L5,L51,L52,L53	Curved Key	Metal	-	20
LA33LUM323	L5,L51,L52,L53	Movable Security Key	Plastic	-	20
LA33LUM324	L5,L51,L52,L53	Movable Security Key	Plastic	-	20



LD11MIP111



LD22MIP211



LD23MIP311



LD23MEM121



LD23SOP101



LD23ROP101



LD33MEP122



LD23SOP103



LD33MIP311



LD33MUM331



LA33LUM323



LA33LUM324



LD51SOM102



LD51SOP102



LD51MEP121



LD51MIP311



LD51MUM331



LD51MEM124



LD51MEM123



LD51MEP123



LK20K13



LK20K25



LK20K28



LK10K13



LK11K13



L5K13



L52K13

Spare Parts - Actuators

Code	Body Type	Actuator	End Unit Material	Features	Box/Pcs
LD33SOM101	L5	Spiral Lever	Metal	Plastic Construction - Multi Way	20
LD33SOP101	L5	Spiral Lever	Plastic	Plastic Construction - Multi Way	20
LD33SOM102	L5	Spiral Arm	Metal	Plastic Construction - Multi Way	20
LD33SOP102	L5	Spiral Arm	Plastic	Plastic Construction - Multi Way	20
LD33LUM321	L5	Hinge	Metal	Metal Construction - Rotating Arm	20
LD33LUM322	L5	Hinge	Metal	Metal Construction - Rotating Arm	20
LD33LEM622	L5	Hinge	Metal	Metal Construction - Rotating Arm	20
LD33BEM621	L5	Rotational Tube	Hinge	Met. Construction-Rotational Tube	20
LD33REF121	L5	Rigid Rod	Fiber	Plastic Construction-Rotating Arm	20
LD51MIM311	L51, L52	Angular Action Roller One Way	Metal	Metal Construction	20
LD51MIP211	L51, L52	Angular Action Roller One Way	Plastic	Metal Construction	20
LD51MIP311	L51, L52	Angular Action Roller Two Way	Plastic	Metal Construction - Rotating Arm	20
LD51MEP121	L51, L52	Angular Action Roller Two Way	Plastic	Metal Construction - Rotating Arm	20
LD51MEM121	L51, L52	Angular Action Roller Two Way	Metal	Metal Construction - Rotating Arm	20
LD51MEP123	L51, L52	Angular Action Roller Two Way	Plastic	Metal Construction - Long Rotating Arm	20
LD51MEM123	L51, L52	Angular Action Roller Two Way	Metal	Metal Construction - Long Rotating Arm	20
LD51MEM124	L51, L52	Angular Action Roller Two Way	Metal	Metal Construction - Long Rotating Arm	20
LD51MEL121	L51, L52	Angular Action Roller Two Way	Rubber	Plastic Construction-Rotating Arm	20
LD51MEL122	L51, L52	Angular Action Roller Two Way	Rubber	Plastic Construction-Rotating Arm	20
LD51MUM331	L51, L52	Plunger with Roll	Metal	Metal Construction	20
LD51SOP101	L51, L52	Spiral Lever	Plastic	Metal Construction - Multi Way	20
LD51SOP102	L51, L52	Spiral Arm	Plastic	Metal Construction - Multi Way	20
LD51SOM102	L51, L52	Spiral Arm	Metal	Metal Construction - Multi Way	20
LD53MIM311	L53, L54	Angular Action Roller One Way	Metal	Metal Construction	20
LD53MIP211	L53, L54	Angular Action Roller One Way	Plastic	Metal Construction	20
LD53MIP311	L53, L54	Angular Action Roller Two Way	Plastic	Metal Construction - Rotating Arm	20
LD53MEP121	L53, L54	Angular Action Roller Two Way	Plastic	Metal Construction - Rotating Arm	20
LD53MEM121	L53, L54	Angular Action Roller Two Way	Metal	Metal Construction - Rotating Arm	20
LD53MEP123	L53, L54	Angular Action Roller Two Way	Plastic	Metal Construction - Long Rotating Arm	20
LD53MEM123	L53, L54	Angular Action Roller Two Way	Metal	Metal Construction - Long Rotating Arm	20
LD53MEM124	L53, L54	Angular Action Roller Two Way	Metal	Metal Construction - Long Rotating Arm	20
LD53MEL121	L53, L54	Angular Action Roller Two Way	Rubber	Plastic Construction - Rotating Arm	20
LD53MEL122	L53, L54	Angular Action Roller Two Way	Rubber	Plastic Construction - Rotating Arm	20
LD53MUM331	L53, L54	Linear Roller	Metal	Metal Construction	20
LD53SOP101	L53, L54	Spiral Arm	Metal	Metal Construction - Multi Way	20
LD53SOP102	L53, L54	Spiral Arm	Plastic	Metal Construction - Multi Way	20
LD53SOM102	L53, L54	Spiral Arm	Metal	Metal Construction - Multi Way	20

Spare Parts - Contact Blocks

Code	Action Type	Contact Block	Plunger Types	Body Type	Box/Pcs
LK10K13	Snap	1 NC + 1 NO	Short	L4	30
LK10K23	Slow	1 NC + 1 NO	Short	L4	30
LK11K13	Snap	1 NC + 1 NO	Long	L4	30
LK11K23	Slow	1 NC + 1 NO	Long	L4	30
LK20K12	Snap	1 NC + 1 NC	Short	L1, L2, L3, L5, L51, L52, L53, L54	30
LK20K13*	Snap	1 NC + 1 NO	Short	L1, L2, L3, L5, L51, L52, L53, L54	30
LK20K23*	Slow	1 NC + 1 NO	Short	L1, L2, L3, L5, L51, L52, L53, L54	30
LK20K25*	Slow	2 NC + 1 NO	Short	L1, L2, L3, L5, L51, L52, L53, L54	30
LK20K27*	Slow	1 NC + 2 NO	Short	L1, L2, L3, L5, L51, L52, L53, L54	30
LK20K28*	Slow	1 NC + 1 NC (serial)	Delayed Short	L1-L54-CSM10	10
LK20K29*	Slow	1 NC + 1 NO	Overlapped Short	L1, L2, L3, L5, L51, L52, L53, L54	30

Body (Housing)

Code	Body Type	Box/Pcs
L1K13	Aluminium	1
L2K13	Aluminium	1
L3K13	Plastic	1
L5K13	Plastic	1
L51K13	Metal	1
L52K13	Metal	1
L53K13	Metal	1
L54K16	Metal	1

* Positive opening Function



SCM30NP1PSX



SMB10LSZ-B15



SPQ50RP2CSX



SIM12NM1RC2



SKM12P4YXV2



SMS10LC2-S15



SIQ18FP1NC2

Sensors

S Series Sensors

- Rapid switching capacity
- Easy to install
- Designed for industrial conditions
- Short circuit and overload protection
- Reverse polarity protection

Inductive Proximity Switches (3 Wire), IP67

SIM12FM1PC2



SIM12NM1RC2



SIM12FM1PSX



SIM18NM1PC2



SIM30NM1RSX



SIM30FM1PC2



SIQ18FP1NC2

Code	Body Type	Voltage	Sensing Distance	Mounting	Switching Frequency	Connection	Output
SIM12FM1NC2	Cylinder 12	10-30 V DC	2 mm	Flush	800 Hz	Wire Connection (2m)	NPN-NO
SIM12FM1NSX	Cylinder 12	10-30 V DC	2 mm	Flush	800 Hz	M12 Connector	NPN-NO
SIM12FM1OC2	Cylinder 12	10-30 V DC	2 mm	Flush	800 Hz	Wire Connection (2m)	NPN-NC
SIM12FM1OSX	Cylinder 12	10-30 V DC	2 mm	Flush	800 Hz	M12 Connector	NPN-NC
SIM12FM1PC2	Cylinder 12	10-30 V DC	2 mm	Flush	800 Hz	Wire Connection (2m)	PNP-NO
SIM12FM1PSX	Cylinder 12	10-30 V DC	2 mm	Flush	800 Hz	M12 Connector	PNP-NO
SIM12FM1RC2	Cylinder 12	10-30 V DC	2 mm	Flush	800 Hz	Wire Connection (2m)	PNP-NC
SIM12FM1RSX	Cylinder 12	10-30 V DC	2 mm	Flush	800 Hz	M12 Connector	PNP-NC
SIM12NM1NC2	Cylinder 12	10-30 V DC	4 mm	Nonflush	400 Hz	Wire Connection (2m)	NPN-NO
SIM12NM1NSX	Cylinder 12	10-30 V DC	4 mm	Nonflush	400 Hz	M12 Connector	NPN-NO
SIM12NM1OC2	Cylinder 12	10-30 V DC	4 mm	Nonflush	400 Hz	Wire Connection (2m)	NPN-NC
SIM12NM1OSX	Cylinder 12	10-30 V DC	4 mm	Nonflush	400 Hz	M12 Connector	NPN-NC
SIM12NM1PC2	Cylinder 12	10-30 V DC	4 mm	Nonflush	400 Hz	Wire Connection (2m)	PNP-NO
SIM12NM1PSX	Cylinder 12	10-30 V DC	4 mm	Nonflush	400 Hz	M12 Connector	PNP-NO
SIM12NM1RC2	Cylinder 12	10-30 V DC	4 mm	Nonflush	400 Hz	Wire Connection (2m)	PNP-NC
SIM12NM1RSX	Cylinder 12	10-30 V DC	4 mm	Nonflush	400 Hz	M12 Connector	PNP-NC
SIM18FM1NC2	Cylinder 18	10-30 V DC	5 mm	Flush	800 Hz	Wire Connection (2m)	NPN-NO
SIM18FM1NSX	Cylinder 18	10-30 V DC	5 mm	Flush	800 Hz	M12 Connector	NPN-NO
SIM18FM1OC2	Cylinder 18	10-30 V DC	5 mm	Flush	800 Hz	Wire Connection (2m)	NPN-NC
SIM18FM1OSX	Cylinder 18	10-30 V DC	5 mm	Flush	800 Hz	M12 Connector	NPN-NC
SIM18FM1PC2	Cylinder 18	10-30 V DC	5 mm	Flush	800 Hz	Wire Connection (2m)	PNP-NO
SIM18FM1PSX	Cylinder 18	10-30 V DC	5 mm	Flush	800 Hz	M12 Connector	PNP-NO
SIM18FM1RC2	Cylinder 18	10-30 V DC	5 mm	Flush	800 Hz	Wire Connection (2m)	PNP-NC
SIM18FM1RSX	Cylinder 18	10-30 V DC	5 mm	Flush	800 Hz	M12 Connector	PNP-NC
SIM18NM1NC2	Cylinder 18	10-30 V DC	8 mm	Nonflush	400 Hz	Wire Connection (2m)	NPN-NO
SIM18NM1NSX	Cylinder 18	10-30 V DC	8 mm	Nonflush	400 Hz	M12 Connector	NPN-NO
SIM18NM1OC2	Cylinder 18	10-30 V DC	8 mm	Nonflush	400 Hz	Wire Connection (2m)	NPN-NC
SIM18NM1OSX	Cylinder 18	10-30 V DC	8 mm	Nonflush	400 Hz	M12 Connector	NPN-NC
SIM18NM1PC2	Cylinder 18	10-30 V DC	8 mm	Nonflush	400 Hz	Wire Connection (2m)	PNP-NO
SIM18NM1PSX	Cylinder 18	10-30 V DC	8 mm	Nonflush	400 Hz	M12 Connector	PNP-NO
SIM18NM1RC2	Cylinder 18	10-30 V DC	8 mm	Nonflush	400 Hz	Wire Connection (2m)	PNP-NC
SIM18NM1RSX	Cylinder 18	10-30 V DC	8 mm	Nonflush	400 Hz	M12 Connector	PNP-NC
SIM30FM1NC2	Cylinder 30	10-30 V DC	10 mm	Flush	400 Hz	Wire Connection (2m)	NPN-NO
SIM30FM1NSX	Cylinder 30	10-30 V DC	10 mm	Flush	400 Hz	M12 Connector	NPN-NO
SIM30FM1OC2	Cylinder 30	10-30 V DC	10 mm	Flush	400 Hz	Wire Connection (2m)	NPN-NC
SIM30FM1OSX	Cylinder 30	10-30 V DC	10 mm	Flush	400 Hz	M12 Connector	NPN-NC
SIM30FM1PC2	Cylinder 30	10-30 V DC	10 mm	Flush	400 Hz	Wire Connection (2m)	PNP-NO
SIM30FM1PSX	Cylinder 30	10-30 V DC	10 mm	Flush	400 Hz	M12 Connector	PNP-NO
SIM30FM1RC2	Cylinder 30	10-30 V DC	10 mm	Flush	400 Hz	Wire Connection (2m)	PNP-NC
SIM30FM1RSX	Cylinder 30	10-30 V DC	10 mm	Flush	400 Hz	M12 Connector	PNP-NC
SIM30NM1NC2	Cylinder 30	10-30 V DC	15 mm	Nonflush	200 Hz	Wire Connection (2m)	NPN-NO
SIM30NM1NSX	Cylinder 30	10-30 V DC	15 mm	Nonflush	200 Hz	M12 Connector	NPN-NO
SIM30NM1OC2	Cylinder 30	10-30 V DC	15 mm	Nonflush	200 Hz	Wire Connection (2m)	NPN-NC
SIM30NM1OSX	Cylinder 30	10-30 V DC	15 mm	Nonflush	200 Hz	M12 Connector	NPN-NC
SIM30NM1PC2	Cylinder 30	10-30 V DC	15 mm	Nonflush	200 Hz	Wire Connection (2m)	PNP-NO
SIM30NM1PSX	Cylinder 30	10-30 V DC	15 mm	Nonflush	200 Hz	M12 Connector	PNP-NO
SIM30NM1RC2	Cylinder 30	10-30 V DC	15 mm	Nonflush	200 Hz	Wire Connection (2m)	PNP-NC
SIM30NM1RSX	Cylinder 30	10-30 V DC	15 mm	Nonflush	200 Hz	M12 Connector	PNP-NC
SIQ18FP1NC2	Square 18	10-30V DC	5 mm	Flush	800 Hz	Wire Connection (2m)	NPN-NO
SIQ18FP1NC7	Square 18	10-30V DC	5 mm	Flush	800 Hz	Wire Connection (7m)	NPN-NO
SIQ18FP1OC2	Square 18	10-30V DC	5 mm	Flush	800 Hz	Wire Connection (2m)	NPN-NC
SIQ18FP1OC7	Square 18	10-30V DC	5 mm	Flush	800 Hz	Wire Connection (7m)	NPN-NC
SIQ18FP1PC2	Square 18	10-30V DC	5 mm	Flush	800 Hz	Wire Connection (2m)	PNP-NO
SIQ18FP1PC7	Square 18	10-30V DC	5 mm	Flush	800 Hz	Wire Connection (7m)	PNP-NO
SIQ18FP1RC2	Square 18	10-30V DC	5 mm	Flush	800 Hz	Wire Connection (2m)	PNP-NC
SIQ18FP1RC7	Square 18	10-30V DC	5 mm	Flush	800 Hz	Wire Connection (7m)	PNP-NC

Inductive Proximity Switches (3 Wire), IP67

Code	Body Type	Voltage	Sensing Distance	Mounting	Switching Frequency	Connection	Output
SIQ18NP1NC2	Square 18	10-30V DC	8mm	Nonflush	400 Hz	Wire Connection (2m)	NPN-NO
SIQ18NP1NC7	Square 18	10-30V DC	8mm	Nonflush	400 Hz	Wire Connection (7m)	NPN-NO
SIQ18NP1OC2	Square 18	10-30V DC	8mm	Nonflush	400 Hz	Wire Connection (2m)	NPN-NC
SIQ18NP1OC7	Square 18	10-30V DC	8mm	Nonflush	400 Hz	Wire Connection (7m)	NPN-NC
SIQ18NP1PC2	Square 18	10-30V DC	8mm	Nonflush	400 Hz	Wire Connection (2m)	PNP-NO
SIQ18NP1PC7	Square 18	10-30V DC	8mm	Nonflush	400 Hz	Wire Connection (7m)	PNP-NO
SIQ18NP1RC2	Square 18	10-30V DC	8mm	Nonflush	400 Hz	Wire Connection (2m)	PNP-NC
SIQ18NP1RC7	Square 18	10-30V DC	8mm	Nonflush	400 Hz	Wire Connection (7m)	PNP-NC



SCM18NP1NC2



SCM30NP1PC2

Capacitive Proximity Switches (3 Wire), IP65

Code	Body Type	Voltage	Sensing Distance	Mounting	Body Material	Connection	Output
SCM18NP1NC2	Cylinder 18	10-30 V DC	2-10mm	Nonflush	Plastic	Wire Connection (2m)	NPN-NO
SCM18NP1OC2	Cylinder 18	10-30 V DC	2-10mm	Nonflush	Plastic	Wire Connection (2m)	NPN-NC
SCM18NP1PC2	Cylinder 18	10-30 V DC	2-10mm	Nonflush	Plastic	Wire Connection (2m)	PNP-NO
SCM18NP1RC2	Cylinder 18	10-30 V DC	2-10mm	Nonflush	Plastic	Wire Connection (2m)	PNP-NC
SCM30NM1NC2	Cylinder 30	10-30 V DC	3-15mm	Nonflush	Metal	Wire Connection (2m)	NPN-NO
SCM30NM1NSX	Cylinder 30	10-30 V DC	3-15mm	Nonflush	Metal	M12 Connector	NPN-NO
SCM30NM1OC2	Cylinder 30	10-30 V DC	3-15mm	Nonflush	Metal	Wire Connection (2m)	NPN-NC
SCM30NM1OSX	Cylinder 30	10-30 V DC	3-15mm	Nonflush	Metal	M12 Connector	NPN-NC
SCM30NM1PC2	Cylinder 30	10-30 V DC	3-15mm	Nonflush	Metal	Wire Connection (2m)	PNP-NO
SCM30NM1PSX	Cylinder 30	10-30 V DC	3-15mm	Nonflush	Metal	M12 Connector	PNP-NO
SCM30NM1RC2	Cylinder 30	10-30 V DC	3-15mm	Nonflush	Metal	Wire Connection (2m)	PNP-NC
SCM30NM1RSX	Cylinder 30	10-30 V DC	3-15mm	Nonflush	Metal	M12 Connector	PNP-NC
SCM30NP1NC2	Cylinder 30	10-30 V DC	3-15mm	Nonflush	Plastic	Wire Connection (2m)	NPN-NO
SCM30NP1NSX	Cylinder 30	10-30 V DC	3-15mm	Nonflush	Plastic	M12 Connector	NPN-NO
SCM30NP1OC2	Cylinder 30	10-30 V DC	3-15mm	Nonflush	Plastic	Wire Connection (2m)	NPN-NC
SCM30NP1OSX	Cylinder 30	10-30 V DC	3-15mm	Nonflush	Plastic	M12 Connector	NPN-NC
SCM30NP1PC2	Cylinder 30	10-30 V DC	3-15mm	Nonflush	Plastic	Wire Connection (2m)	PNP-NO
SCM30NP1PSX	Cylinder 30	10-30 V DC	3-15mm	Nonflush	Plastic	M12 Connector	PNP-NO
SCM30NP1RC2	Cylinder 30	10-30 V DC	3-15mm	Nonflush	Plastic	Wire Connection (2m)	PNP-NC
SCM30NP1RSX	Cylinder 30	10-30 V DC	3-15mm	Nonflush	Plastic	M12 Connector	PNP-NC



SPM18DP4DC2



SPQ50RP2CSX

Photoelectric Proximity Switches (4 Wire), IP65

Code	Body Type	Voltage	Sensing Distance	Operating Type	Response Time	Connection	Output
SPM18DP4DC2	Cylinder 18	10-30 V DC	400mm	Diffuse Reflection	2ms	Wire Connection (2m)	PNP 1NO+1NC
SPM18DP4EC2	Cylinder 18	10-30 V DC	400mm	Diffuse Reflection	2ms	Wire Connection (2m)	NPN 1NO+1NC
SPQ50RP2CC2	Square 50	24-240V AC/DC	7 Metre	Retro Reflection	Max. 20ms	Wire Connection (2m)	Relay Output
SPQ50RP2CSX	Square 50	24-240V AC/DC	7 Metre	Retro Reflection	Max. 20ms	Connector M12*4	Relay Output
SPQ50DP2CC2	Square 50	24-240V AC/DC	0,5 Metre	Diffuse Reflection	Max. 20ms	Wire Connection (2m)	Relay Output
SPQ50DP2CSX	Square 50	24-240V AC/DC	0,5 Metre	Diffuse Reflection	Max. 20ms	Connector M12*4	Relay Output

*Reflector is included in the price of 40*60 mm Diffuse Reflection Models.



SMB31LC2-B15



SMB10LSZ-B15



SMS10RC2-S15



SMS10RSZ-S15

Magnetic Switch, IP68

Code	Body Type	Contact Type	Mounting Type	Connection	Features	Sensing Distance	Box/ Pcs
SMB10LC2-B1*	Rectangular 78 mm	1NC+1NO	Left Exit	Wire Connection (2m)		5 mm / 8 mm	1
SMB10LSZ-B1*	Rectangular 78 mm	1NC+1NO	Left Exit	M8*4 Connection		5 mm / 8 mm	1
SMB10RC2-B1*	Rectangular 78 mm	1NC+1NO	Right Exit	Wire Connection (2m)		5 mm / 8 mm	1
SMB10RSZ-B1*	Rectangular 78 mm	1NC+1NO	Right Exit	M8*4 Connection		5 mm / 8 mm	1
SMB11LC2-B1*	Rectangular 78 mm	1NC+1NO	Left Exit	Wire Connection (2m)	LED	5 mm / 8 mm	1
SMB11LSZ-B1*	Rectangular 78 mm	1NC+1NO	Left Exit	M8*4 Connection	LED	5 mm / 8 mm	1
SMB11RC2-B1*	Rectangular 78 mm	1NC+1NO	Right Exit	Wire Connection (2m)	LED	5 mm / 8 mm	1
SMB11RSZ-B1*	Rectangular 78 mm	1NC+1NO	Right Exit	M8*4 Connection	LED	5 mm / 8 mm	1
SMB20LC2-B1*	Rectangular 78 mm	2NC	Left Exit	Wire Connection (2m)		5 mm / 8 mm	1
SMB20LSZ-B1*	Rectangular 78 mm	2NC	Left Exit	M8*4 Connection		5 mm / 8 mm	1
SMB20RC2-B1*	Rectangular 78 mm	2NC	Right Exit	Wire Connection (2m)		5 mm / 8 mm	1
SMB20RSZ-B1*	Rectangular 78 mm	2NC	Right Exit	M8*4 Connection		5 mm / 8 mm	1
SMB21LC2-B1*	Rectangular 78 mm	2NC	Left Exit	Wire Connection (2m)	LED	5 mm / 8 mm	1
SMB21LSZ-B1*	Rectangular 78 mm	2NC	Left Exit	M8*4 Connection	LED	5 mm / 8 mm	1
SMB21RC2-B1*	Rectangular 78 mm	2NC	Right Exit	Wire Connection (2m)	LED	5 mm / 8 mm	1
SMB21RSZ-B1*	Rectangular 78 mm	2NC	Right Exit	M8*4 Connection	LED	5 mm / 8 mm	1
SMB30LC2-B1*	Rectangular 78 mm	2NC+NO	Left Exit	Wire Connection (2m)		5 mm / 8 mm	1
SMB30LSX-B1*	Rectangular 78 mm	2NC+NO	Left Exit	M12*8 Connection		5 mm / 8 mm	1
SMB30RC2-B1*	Rectangular 78 mm	2NC+NO	Right Exit	Wire Connection (2m)		5 mm / 8 mm	1
SMB30RSX-B1*	Rectangular 78 mm	2NC+NO	Right Exit	M12*8 Connection		5 mm / 8 mm	1
SMB31LC2-B1*	Rectangular 78 mm	2NC+NO	Left Exit	Wire Connection (2m)	LED	5 mm / 8 mm	1
SMB31LSX-B1*	Rectangular 78 mm	2NC+NO	Left Exit	M12*8 Connection	LED	5 mm / 8 mm	1
SMB31RC2-B1*	Rectangular 78 mm	2NC+NO	Right Exit	Wire Connection (2m)	LED	5 mm / 8 mm	1
SMB31RSX-B1*	Rectangular 78 mm	2NC+NO	Right Exit	M12*8 Connection	LED	5 mm / 8 mm	1
SMS10LC2-S15	Rectangular 22 mm	1NC+1NO	Left Exit	Wire Connection (2m)		5 mm	1
SMS10LSZ-S15	Rectangular 22 mm	1NC+1NO	Left Exit	M8*4 Connection		5 mm	1
SMS10RC2-S15	Rectangular 22 mm	1NC+1NO	Right Exit	Wire Connection (2m)		5 mm	1
SMS10RSZ-S15	Rectangular 22 mm	1NC+1NO	Right Exit	M8*4 Connection		5 mm	1
SMS11LC2-S15	Rectangular 22 mm	1NC+1NO	Left Exit	Wire Connection (2m)	LED	5 mm	1
SMS11LSZ-S15	Rectangular 22 mm	1NC+1NO	Left Exit	M8*4 Connection	LED	5 mm	1
SMS11RC2-S15	Rectangular 22 mm	1NC+1NO	Right Exit	Wire Connection (2m)	LED	5 mm	1
SMS11RSZ-S15	Rectangular 22 mm	1NC+1NO	Right Exit	M8*4 Connection	LED	5 mm	1
SMS20LC2-S15	Rectangular 22 mm	2NC	Left Exit	Wire Connection (2m)		5 mm	1
SMS20LSZ-S15	Rectangular 22 mm	2NC	Left Exit	M8*4 Connection		5 mm	1

Note 1: SMB10LC2-B1* code means Actuator and Switch together. Switch code is SMB10LC2, Actuator code is SMB15.

Note 2 : * Refers to Sensing Distance, If it is 5 , it means 5 mm sensing distance. If it is 8, it means 8 mm sensing distance.



SMS10LC2-S15

Magnetic Switch, IP68

Code	Body Type	Contact Type	Mounting-Type	Connection	Features	Sensing Distance	Box/ Pcs
SMS20RC2-S15	Rectangular 22 mm	2NC	Right Exit	Wire Connection (2m)		5 mm	1
SMS20RSZ-S15	Rectangular 22 mm	2NC	Right Exit	M8*4 Connection		5 mm	1
SMS21LC2-S15	Rectangular 22 mm	2NC	Left Exit	Wire Connection (2m)	LED	5 mm	1
SMS21LSZ-S15	Rectangular 22 mm	2NC	Left Exit	M8*4 Connection	LED	5 mm	1
SMS21RC2-S15	Rectangular 22 mm	2NC	Right Exit	Wire Connection (2m)	LED	5 mm	1
SMS21RSZ-S15	Rectangular 22 mm	2NC	Right Exit	M8*4 Connection	LED	5 mm	1
SMS30LC2-S15	Rectangular 22 mm	2NC+NO	Left Exit	Wire Connection (2m)		5 mm	1
SMS30LSX-S15	Rectangular 22 mm	2NC+NO	Left Exit	M12*8 Connection		5 mm	1
SMS30RC2-S15	Rectangular 22 mm	2NC+NO	Right Exit	Wire Connection (2m)		5 mm	1
SMS30RSX-S15	Rectangular 22 mm	2NC+NO	Right Exit	M12*8 Connection		5 mm	1
SMS31LC2-S15	Rectangular 22 mm	2NC+NO	Left Exit	Wire Connection (2m)	LED	5 mm	1
SMS31LSX-S15	Rectangular 22 mm	2NC+NO	Left Exit	M12*8 Connection	LED	5 mm	1
SMS31RC2-S15	Rectangular 22 mm	2NC+NO	Right Exit	Wire Connection (2m)	LED	5 mm	1
SMS31RSX-S15	Rectangular 22 mm	2NC+NO	Right Exit	M12*8 Connection	LED	5 mm	1

Note 1: SMB10LC2-B1* code means Actuator and Switch together. Switch code is SMB10LC2, Actuator code is SMB15.



Sensör Tester

Sensor Test Device

Ürün Kodu

SENSOR TESTER



SKM12P4DXV2



SKM12P4YXV2

Connector Cables

Code	Connector Size	Connector Type	Pin	Angle	Cable Material	Cable Length
SKM12P3YXV2	M12	Socket	3		PVC	2 Metre
SKM12P3YXV5	M12	Socket	3		PVC	5 Metre
SKM12F3YXV2	M12	Plug	3		PVC	2 Metre
SKM12F3YXV5	M12	Plug	3		PVC	5 Metre
SKM12P4YXV2	M12	Socket	4		PVC	2 Metre
SKM12P4YXV5	M12	Socket	4		PVC	5 Metre
SKM12F4YXV2	M12	Plug	4		PVC	2 Metre
SKM12F4YXV5	M12	Plug	4		PVC	5 Metre
SKM12P3DXV2	M12	Socket	3	90 Degree	PVC	2 Metre
SKM12P3DXV5	M12	Socket	3	90 Degree	PVC	5 Metre
SKM12F3DXV2	M12	Plug	3	90 Degree	PVC	2 Metre
SKM12F3DXV5	M12	Plug	3	90 Degree	PVC	5 Metre
SKM12P4DXV2	M12	Socket	4	90 Degree	PVC	2 Metre
SKM12P4DXV5	M12	Socket	4	90 Degree	PVC	5 Metre
SKM12F4DXV2	M12	Plug	4	90 Degree	PVC	2 Metre
SKM12F4DXV5	M12	Plug	4	90 Degree	PVC	5 Metre
SKM12P3YXP2	M12	Socket	3		PUR	2 Metre
SKM12P3YXP5	M12	Socket	3		PUR	5 Metre
SKM12F3YXP2	M12	Plug	3		PUR	2 Metre
SKM12F3YXP5	M12	Plug	3		PUR	5 Metre
SKM12P4YXP2	M12	Socket	3		PUR	2 Metre
SKM12P4YXP5	M12	Socket	3		PUR	5 Metre
SKM12F4YXP2	M12	Plug	3		PUR	2 Metre
SKM12F4YXP5	M12	Plug	3		PUR	5 Metre
SKM12P3DXP2	M12	Socket	4	90 Degree	PUR	2 Metre
SKM12P3DXP5	M12	Socket	4	90 Degree	PUR	5 Metre
SKM12F3DXP2	M12	Plug	4	90 Degree	PUR	2 Metre
SKM12F3DXP5	M12	Plug	4	90 Degree	PUR	5 Metre
SKM12P4DXP2	M12	Socket	4	90 Degree	PUR	2 Metre
SKM12P4DXP5	M12	Socket	4	90 Degree	PUR	5 Metre
SKM12F4DXP2	M12	Plug	4	90 Degree	PUR	2 Metre
SKM12F4DXP5	M12	Plug	4	90 Degree	PUR	5 Metre

When you requested double-sided connector cable, the following code should be added at the end of the codes.

A To the other side of cable M8 3 Pin Plug	D To the other side of cable M8 4 Pin Socket	G To the other side of cable M12 4 Pin Plug
B To the other side of cable M8 3 Pin Socket	E To the other side of cable M12 3 Pin Plug	H To the other side of cable M12 4 Pin Socket
C To the other side of cable M8 4 Pin Plug	F To the other side of cable M12 3 Pin Socket	



MN3PUM9



PHE111



PTM111



A14B4K11



A54B1S11



MA111K



MN1MUM8

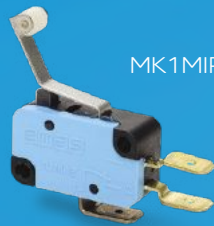

MK1MIP3



A71B1Y11



BS1012



MN2MIM2



MN2KIM2

Basic Switches

MN Series Mini Switch



MN1KIM1

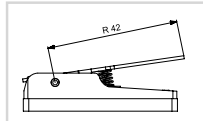

MN+KIM1



MN2KIM2

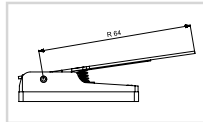

MN+KIM2



MN1KIM3

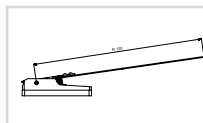

MN+KIM3



MN2MIM1

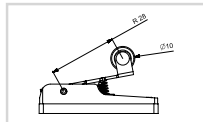

MN+MIM1



MN1MIM1A

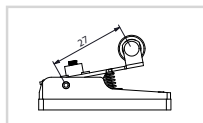

MN+MIM1A



MN2MIM1Y

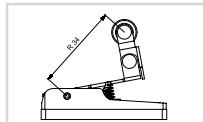

MN+MIM1Y



MN1MIM2

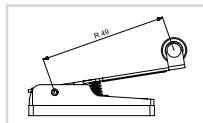

MN+MIM2



MN2MUM3

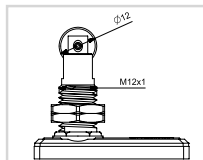

MN+MUM3



MN2MUM8

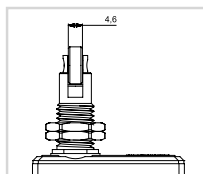

MN+MUM8



MN1MUM9

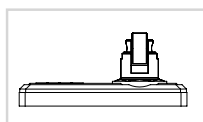

MN+MUM9

	MN1	MN2	MN3 (IP65)	MN4
Box/Pcs	10	10	10	10
Code	MN1KIM1	MN2KIM1	MN3KIM1 (IP65)	MN4KIM1
Contact Type	1 CO	1 CO	1 CO	1 NC+1 NO

Code	MN1KIM2	MN2KIM2	MN3KIM2 (IP65)	MN4KIM2
Contact Type	1 CO	1 CO	1 CO	1 NC+1 NO

Code	MN1KIM3	MN2KIM3	MN3KIM3 (IP65)	MN4KIM3
Contact Type	1 CO	1 CO	1 CO	1 NC+1 NO

Code	MN1MIM1	MN2MIM1	MN3MIM1 (IP65)	MN4MIM1
Contact Type	1 CO	1 CO	1 CO	1 NC+1 NO

Code	MN1MIM1A	MN2MIM1A	MN3MIM1A (IP65)	
Contact Type	1 CO	1 CO	1 CO	

Code	MN1MIM1Y	MN2MIM1Y	MN3MIM1Y (IP65)	MN4MIM1Y
Contact Type	1 CO	1 CO	1 CO	1 NC+1 NO

Code	MN1MIM2	MN2MIM2	MN3MIM2 (IP65)	MN4MIM2
Contact Type	1 CO	1 CO	1 CO	1 NC+1 NO

Code	MN1MUM3	MN2MUM3	MN3MUM3 (IP65)	
Contact Type	1 CO	1 CO	1 CO	

Code	MN1MUM8	MN2MUM8	MN3MUM8 (IP65)	
Contact Type	1 CO	1 CO	1 CO	

Code	MN1MUM9			
Contact Type	1 CO			

MN Series Mini Switch

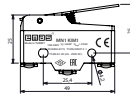

MN1

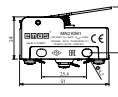

MN2

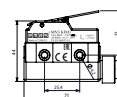

MN3 (IP65)

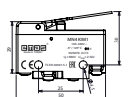

MN4



MN1PUM1

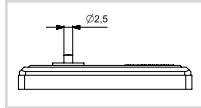

MN+PUM1



MN4PUP1

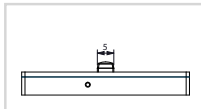

MN+PUP1



MN2PUM3

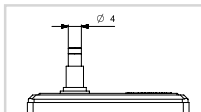

MN+PUM3



MN3PUM7

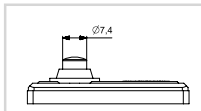

MN+PUM7



MN3PUM9

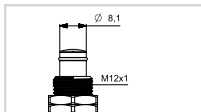

MN+PUM9

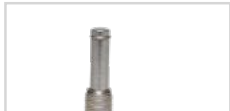

MN1PUM9U

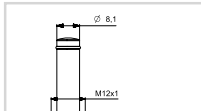

MN+PUM9U



MN2TIP11

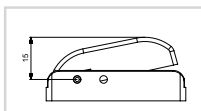

MN+TIP11



MN2TIP11Y

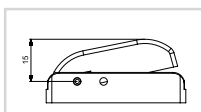

MN+TIP11Y*



MN2TIP1

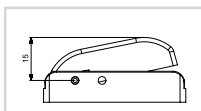

MN+TIP1

Box/Pcs	10	10	10	10
Code	MN1PUM1	MN2PUM1	MN3PUM1 (IP65)	
Contact Type	1 CO	1 CO	1 CO	

Code				MN4PUP1
Contact Type				1 NC+1 NO

Code	MN1PUM3	MN2PUM3	MN3PUM3 (IP65)	
Contact Type	1 CO	1 CO	1 CO	

Code	MN1PUM7	MN2PUM7	MN3PUM7 (IP65)	
Contact Type	1 CO	1 CO	1 CO	

Code	MN1PUM9	MN2PUM9	MN3PUM9 (IP65)	
Contact Type	1 CO	1 CO	1 CO	

Code	MN1PUM9U			
Contact Type	1 CO			

Code		MN2TIP11		
Contact Type		1 NO		

Code		MN2TIP11Y*		
Contact Type		1 NO		

Code		MN2TIP1		
Contact Type		1 CO		

Code	Type	Features	Box/Pcs
MN1YKAP	Protection Cover	Suitable for MN1 and MN2	10

* Hardened spring and green button



MK1PUP1



MK1KIM1



MK1MIP3



MK1KIM5



MK1PUM9



MK1KIM31A

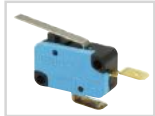

MK1KIM2



MK1KIM3

Micro Switch

Code	Contact Type	Actuator	Actuator Material	Box/Pcs
MK1PUM9	1 CO	Plunger	Metal	10
MK1PUP1	1 CO	Plunger	Plastic	50
MK1PUP1Y	1 CO	Plunger	Soft Plastic	50
MK1KIM1	1 CO	Lever	Metal	50
MK1KIM2	1 CO	Lever	Metal	50
MK1KIM3	1 CO	Lever	Metal	50
MK1KIM31A	1 NC	Lever	Metal	50
MK1KIM4	1 CO	Lever	Metal	50
MK1KIM5	1 CO	Lever	Metal	40
MK1MIM1	1 CO	Roller Lever	Metal	40
MK1MIM2	1 CO	Roller Lever	Metal	40
MK1MIP1	1 CO	Roller Lever	Metal	50
MK1MIP2	1 CO	Roller Lever	Plastic	40
MK1MIP3	1 CO	Roller Lever	Plastic	40



MK1KIM4



MK1MIM1



MK1MIM2



MK1MIP1



MK1MIP2



BS1022



BS1012



BS1010E



BS1012E



BS1011V

Button Switch, IP50

Code	Contact Type	Actuator	Actuator Material	Box/Pcs
BS1010	1 NO, Snap Action	Plunger	Plastic	20
BS1010E	1 NO, Snap Action	Plunger	Plastic with Silicon Cover	16
BS1011	1 NC, Snap Action	Plunger	Plastic	20
BS1011E	1 NC, Snap Action	Plunger	Plastic with Silicon Cover	16
BS1011V	1NO, Snap Action	Plunger (17,20 mm)	Plastic	20
BS1012	1NO+1NC, Snap Action	Plunger	Plastic	20
BS1012E	1NO+1NC, Snap Action	Plunger	Plastic with Silicon Cover	16
BS1020	1 NO, Slow Action	Plunger	Plastic	20
BS1021	1 NC, Slow Action	Plunger	Plastic	20
BS1022	1NO+1NC, Snap Action	Plunger	Plastic	20
BS1040	1 NO, Snap Action	Plunger	Plastic	20
BS1041	1 NC, Snap Action	Plunger	Plastic	20
BS1042	1NO+1NC, Snap Action	Plunger	Plastic	20



BS1010TX1

Button Switches, IP 67

Code	Contact Type	Cable Length	Actuator	Actuator Material	Box/Pcs
BS1010TX1	1NO, Snap Action	1m	Plunger	Plastic, With Silicon Cap	1
BS1011TX1	1NC, Snap Action	1m	Plunger	Plastic, With Silicon Cap	1
BS1012TX1	Double Circuit, Snap Action	1m	Plunger	Plastic, With Silicon Cap	1



MA111



MA211



MA111K



MAK

Toggle Switch

Code	Contact Type	Cable Connection	Actuator Material	Plate	Box/Pcs
MA111	1 NO	2 Screws	Metal	On-Off	10
MA111K	1 NO	2 Screws, With cover	Metal	On-Off	10
MA111L	1 NO	2 Soldering Terminals	Metal	On-Off	10
MA111T	1 NO	2 Terminals	Metal	On-Off	10
MA111TT	1 NO	2 Terminals	Metal	On-Off (Black)	10
MA112	1 NO, 1 NC	3 Screws	Metal	On-On	10
MA113	1 NO, 1 NO	3 Screws	Metal	On-Off-On	10
MA121	1 NO	2 Screws	Metal, Plastic Covered	On-Off	10
MA122	1 NO, 1 NC	3 Screws	Metal, Plastic Covered	On-On	10
MA123	1 NO, 1 NO	3 Screws	Metal, Plastic Covered	On-Off-On	10
MA211	2 NO	4 Screws	Metal	On-Off	6
MA212	2 NO + 2 NC	6 Screws	Metal	On-On	6
MA212T	2 NO + 2 NC	6 Terminals	Metal	On-On	6
MA213	2 NO + 2 NO	6 Screws	Metal	On-Off-On	6
MA213T	2 NO + 2 NO	6 Terminals	Metal	On-Off-On	6
MA221	2 NO	4 Screws	Metal, Plastic Covered	On-Off	6
MA222	2 NO + 2 NC	6 Screws	Metal, Plastic Covered	On-On	6
MA222T	2 NO + 2 NC	6 Terminals	Metal, Plastic Covered	On-On	6
MA223	2 NO + 2 NO	6 Screws	Metal, Plastic Covered	On-Off-On	6
MA223T	2 NO + 2 NC	6 Terminals	Metal, Plastic Covered	On-Off-On	6
MAK	-	-	Plastic	-	10



MAY111



MAY211



MAY213



MAY222

Toggle Switch, Spring Return

Code	Contact Type	Cable Connection	Actuator Material	Plate	Box/Pcs
MAY111	1 NO	2 Screws	Metal	On-Off	10
MAY111L	1 NO	2 Soldering Terminals	Metal	On-Off	10
MAY111T	1 NO	2 Terminals	Metal	On-Off	10
MAY112	1 NO, 1 NO	3 Screws	Metal	On-On	10
MAY113	1 NO, 1 NO	3 Screws	Metal	On-Off-On	10
MAY121	1 NO	2 Screws	Metal, Plastic Covered	On-Off	10
MAY122	1 NO, 1 NO	3 Screws	Metal, Plastic Covered	On-On	10
MAY123	1 NO, 1 NO	3 Screws	Metal, Plastic Covered	On-Off-On	10
MAY211	2 NO	4 Screws	Metal	On-Off	6
MAY212	2 NO + 2 NO	6 Screws	Metal	On-On	6
MAY212T	2 NO + 2 NO	6 Terminals	Metal	On-On	6
MAY213	2 NO + 2 NO	6 Screws	Metal	On-Off-On	6
MAY213T	2 NO + 2 NO	6 Terminals	Metal	On-Off-On	6
MAY221	2 NO	4 Screws	Metal, Plastic Covered	On-Off	6
MAY222	2 NO + 2 NO	6 Screws	Metal, Plastic Covered	On-On	6
MAY222T	2 NO + 2 NO	6 Terminals	Metal, Plastic Covered	On-On	6
MAY223	2 NO + 2 NO	6 Screws	Metal, Plastic Covered	On-Off-On	6



K25001T



K25011V

Medium Voltage Cell Switches

Code	Contact Type	Terminal Type	Box/Pcs
K25001T	2 NC, 1 NO	6 Terminals	10
K25001V	2 NC, 1 NO	6 Screws	10
K25011T	1 NC, 2 NO	6 Terminals	10
K25011V	1 NC, 2 NO	6 Screws	10



A12B1H10



A12B1K11



A12B1S11



A12B1Y11 (3)



A12W1K11



A14B1K11



A21B1H10



A21B1S11



A21B1K11



A54B1H10



A54B1Y11



A71B1K11



A71B1Y11



A71B1S11



EK1



EK2



PTM110



PTM111



PHE110



PTM122

Illuminated Rocker Switch

Code	Housing Type	Housing Colour	Feature	Contact Type	Plate	Button Colour	Cable Connection	Box/Pcs
A12B1H10	30*22mm	Black	WO/Illumination	1NO + 1NO	0-1	H	Terminal	50
A12B1K11	30*22mm	Black	W/Illumination	1NO + 1NO	0-1	K	Terminal	50
A12B1S11	30*22mm	Black	W/Illumination	1NO + 1NO	0-1	S	Terminal	50
A12B1Y11	30*22mm	Black	W/Illumination	1NO + 1NO	0-1	Y	Terminal	50
A12B5H10	30*22mm	Black	WO/Illumination	1NO + 1NO	0-1	H	Bridge	50
A12B5K11	30*22mm	Black	W/Illumination	1NO + 1NO	0-1	K	Bridge	50
A12B5S11	30*22mm	Black	W/Illumination	1NO + 1NO	0-1	S	Bridge	50
A12B5Y11	30*22mm	Black	W/Illumination	1NO + 1NO	0-1	Y	Bridge	50
A12W1H10	30*22mm	White	WO/Illumination	1NO + 1NO	0-1	H	Terminal	50
A12W1K11	30*22mm	White	W/Illumination	1NO + 1NO	0-1	K	Terminal	50
A12W1S11	30*22mm	White	W/Illumination	1NO + 1NO	0-1	S	Terminal	50
A12W1Y11	30*22mm	White	W/Illumination	1NO + 1NO	0-1	Y	Terminal	50
A14B1H10	30*22mm	Black	WO/Illumination	2NO	0-1	H	Terminal	50
A14B1K11	30*22mm	Black	W/Illumination	2NO	0-1	K	Terminal	50
A14B1S11	30*22mm	Black	W/Illumination	2NO	0-1	S	Terminal	50
A14B1Y11	30*22mm	Black	W/Illumination	2NO	0-1	Y	Terminal	50
A14B4H10	30*22mm	Black	WO/Illumination	2NO	0-1	H	Screw	50
A14B4K11	30*22mm	Black	W/Illumination	2NO	0-1	K	Screw	50
A14B4S11	30*22mm	Black	W/Illumination	2NO	0-1	S	Screw	50
A14B4Y11	30*22mm	Black	W/Illumination	2NO	0-1	Y	Screw	50
A14B5H10	30*22mm	Black	WO/Illumination	2NO	0-1	H	Bridge	50
A14B5K11	30*22mm	Black	W/Illumination	2NO	0-1	K	Bridge	50
A14B5S11	30*22mm	Black	W/Illumination	2NO	0-1	S	Bridge	50
A14B5Y11	30*22mm	Black	W/Illumination	2NO	0-1	Y	Bridge	50
A14B6H10	30*22mm	Black	WO/Illumination	2NO	0-1	H	Protected Screw	50
A14B6K11	30*22mm	Black	W/Illumination	2NO	0-1	K	Protected Screw	50
A14B6S11	30*22mm	Black	W/Illumination	2NO	0-1	S	Protected Screw	50
A14B6Y11	30*22mm	Black	W/Illumination	2NO	0-1	Y	Protected Screw	50
A14W1K11	30*22mm	White	W/Illumination	2NO	0-1	K	Terminal	50
A14W1S11	30*22mm	White	W/Illumination	2NO	0-1	S	Terminal	50
A14W1Y11	30*22mm	White	W/Illumination	2NO	0-1	Y	Terminal	50
A14W1BP1K	30*22 mm	White	W/Illumination/ Lens	2NO	0-1	B	Terminal	50
A21B1H10	30*11mm	Black	WO/Illumination	1NO	0-1	H	Terminal	50
A21B1K11	30*11mm	Black	W/Illumination	1NO	0-1	K	Terminal	50
A21B1S11	30*11mm	Black	W/Illumination	1NO	0-1	S	Terminal	50
A21B1Y11	30*11mm	Black	W/Illumination	1NO	0-1	Y	Terminal	50
A21W1K11	30*11mm	White	W/Illumination	1NO	0-1	K	Terminal	50
A21W1S11	30*11mm	White	W/Illumination	1NO	0-1	S	Terminal	50
A21W1Y11	30*11mm	White	W/Illumination	1NO	0-1	Y	Terminal	50
A44B1HX1	20*13 mm	Black	W/Illumination	2NO	-	-	Terminal	50
A44B9HX1	20*13 mm	Black	W/Illumination	2NO	-	-	Terminal + Protected Screw	50
A54B1H10*	30*22mm	Black	WO/Illumination IP65	2NO	0-1	H	Terminal	50
A54B1K11*	30*22mm	Black	W/Illumination IP65	2NO	0-1	K	Terminal	50
A54B1S11*	30*22mm	Black	W/Illumination IP65	2NO	0-1	S	Terminal	50
A54B1Y11*	30*22mm	Black	W/Illumination IP65	2NO	0-1	Y	Terminal	50
A71B1H10	Dia 22mm	Black	WO/Illumination	1NO	0-1	H	Terminal	50
A71B1K11	Dia 22mm	Black	W/Illumination	1NO	0-1	K	Terminal	50
A71B1S11	Dia 22mm	Black	W/Illumination	1NO	0-1	-	Terminal	50
A71B1Y11	Dia 22mm	Black	W/Illumination	1NO	0-1	Y	Terminal	50

* When will be written 25 instead of * it will be 25A.

Code	Type	Box/Pcs
EK1	Silicon Cover, Slim	100
EK2	Silicon Cover, Wide	100

Panel Thermostats

Code	Operation	Feature & Type	Contact	Box/Pcs
PTM110	Mechanical	Thermostat (Panel Type)	NC (Heating-Red)	1
PTM111	Mechanical	Thermostat (Panel Type)	NO (Cooling-Blue)	1
PTM122	Mechanical	Thermostat (Panel Type)	NC (Heating-Red)+NO (Cooling-Blue)	1
PTE110	Electronic	Thermostat (Panel Type)	NC	1
PTE111	Electronic	Thermostat (Panel Type)	NO	1
PHTE124	Analogue (Digital Sensor Included)	Thermostat+Hygrostat (Panel Type)	1 CO	1
PHE110	Electronic	Hygrostat (Panel Type)	NC	1
PHE111	Electronic	Hygrostat (Panel Type)	NO	1



PSA050AK331S+PSPK0501



PSK21



PSA010AK131SAQ



PSA020OK723S



PSA020KS127S



PSA020AK231K



PSA020KD333S



PSA020MS335S



PSPK0501



PSR2



PSA020KD334S



PSA010AK141EQ

Rotary Cam Switches

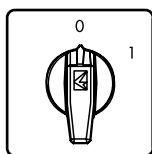

"0-1" On-Off Cam Switches - 60°

Code	Poles	Rated Thermal Current (A)	Enclosure	Key Operated	Quick Installation	Key Operated & Quick Installation With Plate	Lockable Handle With Plate
PSA010AK131S	1 Pole	10	PSK11	✓	✓	✓	✓
PSA016AK131S	1 Pole	16	PSK11	✓	✓	✓	✓
PSA020AK131S	1 Pole	20	PSK11	✓	✓	✓	✓
PSA025AK131S	1 Pole	25	PSK11	✓	✓	✓	✓
PSA032AK131S	1 Pole	32	PSK21				
PSA040AK131S	1 Pole	40	PSK21				
PSA050AK131S	1 Pole	50	PSK31				
PSA063AK131S	1 Pole	63	PSK31				
PSA080AK131S	1 Pole	80	-				
PSA120AK131S	1 Pole	120	-				



PSA020AK131S

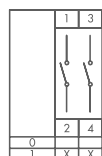

PSA020AK231S

PSA010AK231S	2 Poles	10	PSK11	✓	✓	✓	✓
PSA016AK231S	2 Poles	16	PSK11	✓	✓	✓	✓
PSA020AK231S	2 Poles	20	PSK11	✓	✓	✓	✓
PSA025AK231S	2 Poles	25	PSK11	✓	✓	✓	✓
PSA032AK231S	2 Poles	32	PSK21				
PSA040AK231S	2 Poles	40	PSK21				
PSA050AK231S	2 Poles	50	PSK31				
PSA063AK231S	2 Poles	63	PSK31				
PSA080AK231S	2 Poles	80	-				
PSA120AK231S	2 Poles	120	-				

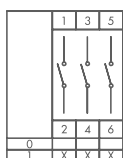

PSA020AK331S

PSA010AK331S	3 Poles	10	PSK11	✓	✓	✓	✓
PSA016AK331S	3 Poles	16	PSK11	✓	✓	✓	✓
PSA020AK331S	3 Poles	20	PSK11	✓	✓	✓	✓
PSA025AK331S	3 Poles	25	PSK11	✓	✓	✓	✓
PSA032AK331S	3 Poles	32	PSK21				
PSA040AK331S	3 Poles	40	PSK21				
PSA050AK331S	3 Poles	50	PSK31				
PSA063AK331S	3 Poles	63	PSK31				
PSA080AK331S	3 Poles	80	-				
PSA120AK331S	3 Poles	120	-				

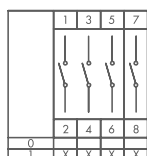

PSA020AK431S

PSA010AK431S	4 Poles	10	PSK11	✓	✓	✓	✓
PSA016AK431S	4 Poles	16	PSK11	✓	✓	✓	✓
PSA020AK431S	4 Poles	20	PSK11	✓	✓	✓	✓
PSA025AK431S	4 Poles	25	PSK11	✓	✓	✓	✓
PSA032AK431S	4 Poles	32	PSK21				
PSA040AK431S	4 Poles	40	PSK21				
PSA050AK431S	4 Poles	50	PSK31				
PSA063AK431S	4 Poles	63	PSK31				
PSA080AK431S	4 Poles	80	-				
PSA120AK431S	4 Poles	120	-				

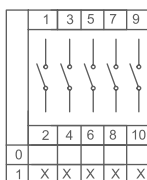

PSA010AK531S	5 Poles	10	PSK12	✓	✓	✓	✓
PSA016AK531S	5 Poles	16	PSK12	✓	✓	✓	✓
PSA020AK531S	5 Poles	20	PSK12	✓	✓	✓	✓
PSA025AK531S	5 Poles	25	PSK12	✓	✓	✓	✓
PSA032AK531S	5 Poles	32	PSK22				
PSA040AK531S	5 Poles	40	PSK22				
PSA050AK531S	5 Poles	50					
PSA063AK531S	5 Poles	63					
PSA080AK531S	5 Poles	80					
PSA120AK531S	5 Poles	120					

* Can be supplied with Red-Yellow head w/o extra charge, in this case please replace "S" at the end with "E".

** 10-25A Cam Switches can be supplied with big frame (64 x 64) with extra charge, In this case please replace the "S" at the end with "B".

*** Please replace "S" letter at the end of the code with "SAQ" for Key Operated & Quick Installation With Plate Model (with extra charge)

**** Please replace "S" letter at the end of the code with "K" for Lockable Handle model (with extra charge)

***** Please replace "S" letter at the end of the code with "SQ" for Quick Installation model (with extra charge)

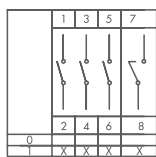

PSA020AK831S

"0-1" On-Off Cam Switches - 60°

Code	Poles	Rated Thermal Current (A)	Enclosure	Key Operated	Quick Installation	Key Operated & Quick Installation With Plate	Lockable Handle With Plate
PSA010AK831S	3 Poles+Neutral	10	PSK11	✓	✓	✓	✓
PSA016AK831S	3 Poles+Neutral	16	PSK11	✓	✓	✓	✓
PSA020AK831S	3 Poles+Neutral	20	PSK11	✓	✓	✓	✓
PSA025AK831S	3 Poles+Neutral	25	PSK11	✓	✓	✓	✓
PSA032AK831S	3 Poles+Neutral	32	PSK21				
PSA040AK831S	3 Poles+Neutral	40	PSK21				
PSA050AK831S	3 Poles+Neutral	50	PSK31				
PSA063AK831S	3 Poles+Neutral	63	PSK31				
PSA080AK831S	3 Poles+Neutral	80	-				
PSA120AK831S	3 Poles+Neutral	120	-				

* Can be supplied with Red-Yellow head w/o extra charge, in this case please replace "S" at the end with "E".

** 10-25A Cam Switches can be supplied with big frame (64 x 64) with extra charge, In this case please replace the "S" at the end with "B".

*** Please replace "S" letter at the end of the code with "SAQ" for Key Operated & Quick Installation With Plate Model (with extra charge)

**** Please replace "S" letter at the end of the code with "K" for Lockable Handle model (with extra charge)

***** Please replace "S" letter at the end of the code with "SQ" for Quick Installation model (with extra charge)

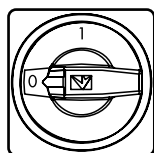

"0-1" Safety On-Off Cam Switches - 90°

Code	Poles	Rated Thermal Current (A)	Enclosure	Key Operated	Quick Installation	Key Operated & Quick Installation With Plate	Lockable Handle With Plate
PSA010AK141E	1 Pole	10	PSK11		✓		✓
PSA016AK141E	1 Pole	16	PSK11		✓		✓
PSA020AK141E	1 Pole	20	PSK11		✓		✓
PSA025AK141E	1 Pole	25	PSK11		✓		✓
PSA032AK141E	1 Pole	32	PSK21				
PSA040AK141E	1 Pole	40	PSK21				
PSA050AK141E	1 Pole	50	PSK31				
PSA063AK141E	1 Pole	63	PSK31				
PSA080AK141E	1 Pole	80	-				
PSA120AK141E	1 Pole	120	-				



PSA020AK141E

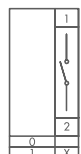

PSA020AK241E

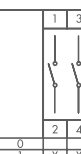

PSA010AK241E	2 Poles	10	PSK11		✓		✓
PSA016AK241E	2 Poles	16	PSK11		✓		✓
PSA020AK241E	2 Poles	20	PSK11		✓		✓
PSA025AK241E	2 Poles	25	PSK11		✓		✓
PSA032AK241E	2 Poles	32	PSK21				
PSA040AK241E	2 Poles	40	PSK21				
PSA050AK241E	2 Poles	50	PSK31				
PSA063AK241E	2 Poles	63	PSK31				
PSA080AK241E	2 Poles	80	-				
PSA120AK241E	2 Poles	120	-				



PSA020AK341E

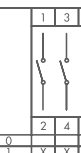

PSA010AK341E	3 Poles	10	PSK11		✓		✓
PSA016AK341E	3 Poles	16	PSK11		✓		✓
PSA020AK341E	3 Poles	20	PSK11		✓		✓
PSA025AK341E	3 Poles	25	PSK11		✓		✓
PSA032AK341E	3 Poles	32	PSK21				
PSA040AK341E	3 Poles	40	PSK21				
PSA050AK341E	3 Poles	50	PSK31				
PSA063AK341E	3 Poles	63	PSK31				
PSA080AK341E	3 Poles	80	-				
PSA120AK341E	3 Poles	120	-				

* 10-25A Cam Switches can be supplied with big frame (64 x 64) with extra charge, In this case please replace the "F" at the end with "E".

** Please replace "E" letter at the end of the code with "EQ" for Quick Installation model (with extra charge)

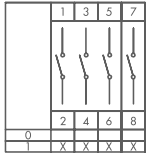

PSA020AK441E

"0-1" Safety On-Off Cam Switches - 90°

Code	Poles	Rated Thermal Current (A)	Enclosure	Key Operated	Quick Installation	Key Operated & Quick Installation With Plate	Lockable Handle With Plate
PSA010AK441E	4 Poles	10	PSK11		✓		✓
PSA016AK441E	4 Poles	16	PSK11		✓		✓
PSA020AK441E	4 Poles	20	PSK11		✓		✓
PSA025AK441E	4 Poles	25	PSK11		✓		✓
PSA032AK441E	4 Poles	32	PSK21				
PSA040AK441E	4 Poles	40	PSK21				
PSA050AK441E	4 Poles	50	PSK31				
PSA063AK441E	4 Poles	63	PSK31				
PSA080AK441E	4 Poles	80	-				
PSA120AK441E	4 Poles	120	-				

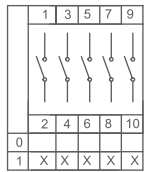

PSA010AK541E	5 Poles	10	PSK12		✓		✓
PSA016AK541E	5 Poles	16	PSK12		✓		✓
PSA020AK541E	5 Poles	20	PSK12		✓		✓
PSA025AK541E	5 Poles	25	PSK12		✓		✓
PSA032AK541E	5 Poles	32	PSK22				
PSA040AK541E	5 Poles	40	PSK22				
PSA050AK541E	5 Poles	50					
PSA063AK541E	5 Poles	63					
PSA080AK541E	5 Poles	80					
PSA120AK541E	5 Poles	120					

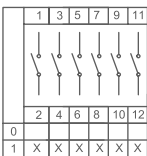

PSA010AK641E	6 Poles	10	PSK12		✓		✓
PSA016AK641E	6 Poles	16	PSK12		✓		✓
PSA020AK641E	6 Poles	20	PSK12		✓		✓
PSA025AK641E	6 Poles	25	PSK12		✓		✓
PSA032AK641E	6 Poles	32	PSK22				
PSA040AK641E	6 Poles	40	PSK22				
PSA050AK641E	6 Poles	50					
PSA063AK641E	6 Poles	63					
PSA080AK641E	6 Poles	80					
PSA120AK641E	6 Poles	120					

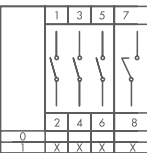

PSA020AK941E

PSA010AK941E	3 Poles+Neutral	10	PSK11		✓		✓
PSA016AK941E	3 Poles+Neutral	16	PSK11		✓		✓
PSA020AK941E	3 Poles+Neutral	20	PSK11		✓		✓
PSA025AK941E	3 Poles+Neutral	25	PSK11		✓		✓
PSA032AK941E	3 Poles+Neutral	32	PSK21				
PSA040AK941E	3 Poles+Neutral	40	PSK21				
PSA050AK941E	3 Poles+Neutral	50	PSK31				
PSA063AK941E	3 Poles+Neutral	63	PSK31				
PSA080AK941E	3 Poles+Neutral	80	-				
PSA120AK941E	3 Poles+Neutral	120	-				

· 10-25A Cam Switches can be supplied with big frame (64 x 64) with extra charge, in this case please replace the "E" at the end with "F"
 · Please replace "E" letter at the end of the code with "EQ" for Quick Installation model (with extra charge)

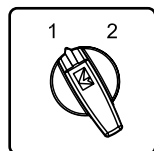

1-2 Changeover Cam Switches - 60°

Code	Poles	Rated Thermal Current (A)	Enclosure	Key Operated	Quick Installation	Key Operated & Quick Installation With Plate	Lockable Handle With Plate
PSA010KD133S	1 Pole	10	PSK11	✓	✓	✓	✓
PSA016KD133S	1 Pole	16	PSK11	✓	✓	✓	✓
PSA020KD133S	1 Pole	20	PSK11	✓	✓	✓	✓
PSA025KD133S	1 Pole	25	PSK11	✓	✓	✓	✓
PSA032KD133S	1 Pole	32	PSK21				
PSA040KD133S	1 Pole	40	PSK21				
PSA050KD133S	1 Pole	50	PSK31				
PSA063KD133S	1 Pole	63	PSK31				
PSA080KD133S	1 Pole	80	-				
PSA120KD133S	1 Pole	120	-				

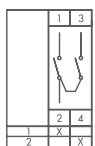

PSA020KD133S

* Can be supplied with Red-Yellow head w/o extra charge, in this case please replace "S" at the end with "E".

** 10-25A Cam Switches can be supplied with big frame (64 x 64) with extra charge, In this case please replace the "S" at the end with "B"

*** Please replace "S" letter at the end of the code with "SAQ" for Key Operated & Quick Installation With Plate Model (with extra charge)

**** Please replace "S" letter at the end of the code with "K" for Lockable Handle model (with extra charge)

***** Please replace "S" letter at the end of the code with "SQ" for Quick Installation model (with extra charge)

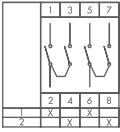

"1-2" Changeover Cam Switches - 60°

Code	Poles	Rated Thermal Current (A)	Enclosure	Key Operated	Quick Installation	Key Operated & Quick Installation With Plate	Lockable Handle With Plate
PSA010KD233S	2 Poles	10	PSK11	✓	✓	✓	✓
PSA016KD233S	2 Poles	16	PSK11	✓	✓	✓	✓
PSA020KD233S	2 Poles	20	PSK11	✓	✓	✓	✓
PSA025KD233S	2 Poles	25	PSK11	✓	✓	✓	✓
PSA032KD233S	2 Poles	32	PSK31				
PSA040KD233S	2 Poles	40	PSK31				
PSA050KD233S	2 Poles	50	-				
PSA063KD233S	2 Poles	63	-				
PSA080KD233S	2 Poles	80	-				
PSA120KD233S	2 Poles	120	-				

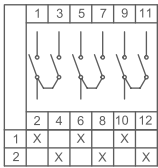

PSA020KD333S

PSA010KD333S	3 Poles	10	PSK12	✓	✓	✓	✓
PSA016KD333S	3 Poles	16	PSK12	✓	✓	✓	✓
PSA020KD333S	3 Poles	20	PSK12	✓	✓	✓	✓
PSA025KD333S	3 Poles	25	PSK12	✓	✓	✓	✓
PSA032KD333S	3 Poles	32	PSK31				
PSA040KD333S	3 Poles	40	PSK31				
PSA050KD333S	3 Poles	50	-				
PSA063KD333S	3 Poles	63	-				
PSA080KD333S	3 Poles	80	-				
PSA120KD333S	3 Poles	120	-				

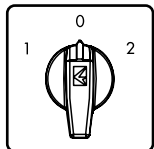

"1-0-2" Changeover Cam Switches - 60°

Code	Poles	Rated Thermal Current (A)	Enclosure	Key Operated	Quick Installation	Key Operated & Quick Installation With Plate	Lockable Handle With Plate
PSA010KD134S	1 Pole	10	PSK11	✓	✓	✓	✓
PSA016KD134S	1 Pole	16	PSK11	✓	✓	✓	✓
PSA020KD134S	1 Pole	20	PSK11	✓	✓	✓	✓
PSA025KD134S	1 Pole	25	PSK11	✓	✓	✓	✓
PSA032KD134S	1 Pole	32	PSK21				
PSA040KD134S	1 Pole	40	PSK21				
PSA050KD134S	1 Pole	50	PSK31				
PSA063KD134S	1 Pole	63	PSK31				
PSA080KD134S	1 Pole	80	-				
PSA120KD134S	1 Pole	120	-				

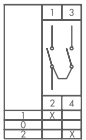

PSA020KD134S

PSA010KD234S	2 Poles	10	PSK11	✓	✓	✓	✓
PSA016KD234S	2 Poles	16	PSK11	✓	✓	✓	✓
PSA020KD234S	2 Poles	20	PSK11	✓	✓	✓	✓
PSA025KD234S	2 Poles	25	PSK11	✓	✓	✓	✓
PSA032KD234S	2 Poles	32	PSK21				
PSA040KD234S	2 Poles	40	PSK21				
PSA050KD234S	2 Poles	50	PSK31				
PSA063KD234S	2 Poles	63	PSK31				
PSA080KD234S	2 Poles	80	-				
PSA120KD234S	2 Poles	120	-				

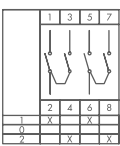

PSA020KD234S

PSA010KD334S	3 Poles	10	PSK12	✓	✓	✓	✓
PSA016KD334S	3 Poles	16	PSK12	✓	✓	✓	✓
PSA020KD334S	3 Poles	20	PSK12	✓	✓	✓	✓
PSA025KD334S	3 Poles	25	PSK12	✓	✓	✓	✓
PSA032KD334S	3 Poles	32	PSK22				
PSA040KD334S	3 Poles	40	PSK22				
PSA050KD334S	3 Poles	50	-				
PSA063KD334S	3 Poles	63	-				
PSA080KD334S	3 Poles	80	-				
PSA120KD334S	3 Poles	120	-				

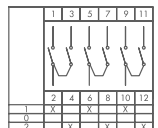

PSA020KD334S

* Can be supplied with Red-Yellow head w/o extra charge, in this case please replace "S" at the end with "E".

** 10-25A Cam Switches can be supplied with big frame (64 x 64) with extra charge, In this case please replace the "S" at the end with "B"

*** Please replace "S" letter at the end of the code with "SAQ" for Key Operated & Quick Installation With Plate Model (with extra charge)

**** Please replace "S" letter at the end of the code with "K" for Lockable Handle model (with extra charge)

***** Please replace "S" letter at the end of the code with "SQ" for Quick Installation model (with extra charge)



PSA020KD434S

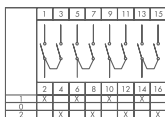

Code	Poles	Rated Thermal Current (A)	Enclosure	Key Operated	Quick Installation	Key Operated & Quick Installation With Plate	Lockable Handle With Plate
PSA010KD434S	4 Poles	10	PSK12	✓	✓	✓	✓
PSA016KD434S	4 Poles	16	PSK12	✓	✓	✓	✓
PSA020KD434S	4 Poles	20	PSK12	✓	✓	✓	✓
PSA025KD434S	4 Poles	25	PSK12	✓	✓	✓	✓
PSA032KD434S	4 Poles	32	PSK22				
PSA040KD434S	4 Poles	40	PSK22				
PSA050KD434S	4 Poles	50					
PSA063KD434S	4 Poles	63					
PSA080KD434S	4 Poles	80	-				
PSA120KD434S	4 Poles	120	-				

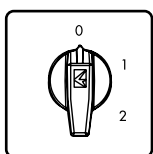

PSA020KS132S

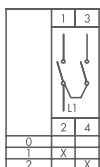

Step Cam Switches - 1 Pole							
Code	Poles	Rated Thermal Current (A)	Enclosure	Key Operated	Quick Installation	Key Operated & Quick Installation With Plate	Lockable Handle With Plate
PSA010KS132S	0-1-2	10	PSK11	✓	✓	✓	✓
PSA016KS132S	0-1-2	16	PSK11	✓	✓	✓	✓
PSA020KS132S	0-1-2	20	PSK11	✓	✓	✓	✓
PSA025KS132S	0-1-2	25	PSK11	✓	✓	✓	✓
PSA032KS132S	0-1-2	32	PSK21				
PSA040KS132S	0-1-2	40	PSK21				
PSA050KS132S	0-1-2	50	PSK31				
PSA063KS132S	0-1-2	63	PSK31				
PSA080KS132S	0-1-2	80	-				
PSA120KS132S	0-1-2	120	-				

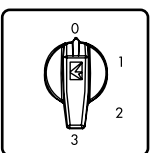

PSA020KS133S

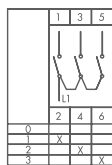

PSA010KS133S	0-3	10	PSK11	✓	✓	✓	✓
PSA016KS133S	0-3	16	PSK11	✓	✓	✓	✓
PSA020KS133S	0-3	20	PSK11	✓	✓	✓	✓
PSA025KS133S	0-3	25	PSK11	✓	✓	✓	✓
PSA032KS133S	0-3	32	PSK21				
PSA040KS133S	0-3	40	PSK21				
PSA050KS133S	0-3	50	PSK31				
PSA063KS133S	0-3	63	PSK32				
PSA080KS133S	0-3	80	-				
PSA120KS133S	0-3	120	-				

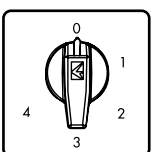

PSA020KS134S

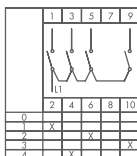

PSA010KS134S	0-4	10	PSK12	✓	✓	✓	✓
PSA016KS134S	0-4	16	PSK12	✓	✓	✓	✓
PSA020KS134S	0-4	20	PSK12	✓	✓	✓	✓
PSA025KS134S	0-4	25	PSK12	✓	✓	✓	✓
PSA032KS134S	0-4	32	PSK22				
PSA040KS134S	0-4	40	PSK22				
PSA050KS134S	0-4	50	PSK32				
PSA063KS134S	0-4	63	PSK32				
PSA080KS134S	0-4	80	-				
PSA120KS134S	0-4	120	-				

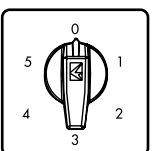

PSA020KS135S

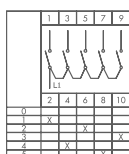

PSA010KS135S	0-5	10	PSK12	✓	✓	✓	✓
PSA016KS135S	0-5	16	PSK12	✓	✓	✓	✓
PSA020KS135S	0-5	20	PSK12	✓	✓	✓	✓
PSA025KS135S	0-5	25	PSK12	✓	✓	✓	✓
PSA032KS135S	0-5	32	PSK22				
PSA040KS135S	0-5	40	PSK22				
PSA050KS135S	0-5	50					
PSA063KS135S	0-5	63					
PSA080KS135S	0-5	80	-				
PSA120KS135S	0-5	120	-				

* Can be supplied with Red-Yellow head w/o extra charge, in this case please replace "S" at the end with "E".

** 10-25A Cam Switches can be supplied with big frame (64 x 64) with extra charge, In this case please replace the "S" at the end with "B"

***Please replace "S" letter at the end of the code with "SAQ" for Key Operated & Quick Installation With Plate Model (with extra charge)

**** Please replace "S" letter at the end of the code with "SQ" for Quick Installation model (with extra charge)

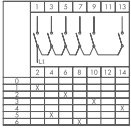
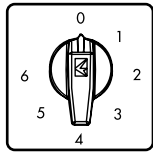

PSA020KS126S

Code	Poles	Rated Thermal Current (A)	Enclosure	Key Operated	Quick Installation	Key Operated & Quick Installation With Plate	Lockable Handle With Plate
PSA010KS126S	0-6	10	PSK12	✓	✓	✓	✓
PSA016KS126S	0-6	16	PSK12	✓	✓	✓	✓
PSA020KS126S	0-6	20	PSK12	✓	✓	✓	✓
PSA025KS126S	0-6	25	PSK12	✓	✓	✓	✓
PSA032KS126S	0-6	32	PSK22				
PSA040KS126S	0-6	40	PSK22				
PSA050KS126S	0-6	50	-				
PSA063KS126S	0-6	63	-				
PSA080KS126S	0-6	80	-				
PSA120KS126S	0-6	120	-				

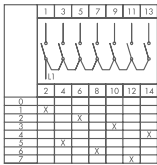
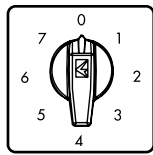

PSA020KS127S

PSA010KS127S	0-7	10	PSK12	✓	✓	✓	✓
PSA016KS127S	0-7	16	PSK12	✓	✓	✓	✓
PSA020KS127S	0-7	20	PSK12	✓	✓	✓	✓
PSA025KS127S	0-7	25	PSK12	✓	✓	✓	✓
PSA032KS127S	0-7	32	PSK22				
PSA040KS127S	0-7	40	PSK22				
PSA050KS127S	0-7	50	-				
PSA063KS127S	0-7	63	-				
PSA080KS127S	0-7	80	-				
PSA120KS127S	0-7	120	-				

Step Cam Switches - 60°

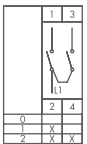
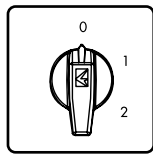

PSA020KT132S

Code	Poles	Rated Thermal Current (A)	Steps	Enclosure	Key Operated	Quick Installation	Key Operated & Quick Installation With Plate	Lockable Handle With Plate
PSA010KT132S	1 Pole	10	0-1-2	PSK11	✓	✓	✓	✓
PSA016KT132S	1 Pole	16	0-1-2	PSK11	✓	✓	✓	✓
PSA020KT132S	1 Pole	20	0-1-2	PSK11	✓	✓	✓	✓
PSA025KT132S	1 Pole	25	0-1-2	PSK11	✓	✓	✓	✓
PSA010KT332S	3 Poles	10	0-1-2	PSK12	✓			
PSA016KT332S	3 Poles	16	0-1-2	PSK12	✓			

Star-Delta Cam Switches - 60°

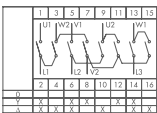
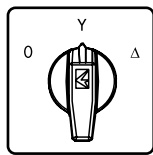

PSA020MS335S

Code	Poles	Rated Thermal Current (A)	Enclosure	Key Operated	Quick Installation	Key Operated & Quick Installation With Plate	Lockable Handle With Plate
PSA010MS335S	3 Phase	10	PSK12	✓	✓	✓	✓
PSA016MS335S	3 Phase	16	PSK12	✓	✓	✓	✓
PSA020MS335S	3 Phase	20	PSK12	✓	✓	✓	✓
PSA025MS335S	3 Phase	25	PSK12	✓	✓	✓	✓
PSA032MS335S	3 Phase	32	PSK22				
PSA040MS335S	3 Phase	40	PSK22				
PSA050MS335S	3 Phase	50	-				
PSA063MS335S	3 Phase	63	-				
PSA080MS335S	3 Phase	80	-				
PSA120MS335S	3 Phase	120	-				

* Can be supplied with Red-Yellow head w/o extra charge, in this case please replace "S" at the end with "E".

** 10-25A Cam Switches can be supplied with big frame (64 x 64) with extra charge, In this case please replace the "S" at the end with "B".

***Please replace "S" letter at the end of the code with "SAQ" for Key Operated & Quick Installation With Plate Model (with extra charge)

**** Please replace "S" letter at the end of the code with "SQ" for Quick Installation model (with extra charge)

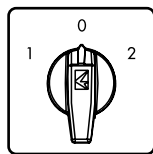

1 Pole Change Over Cam Switches "1-0-2"

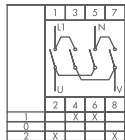

PSA020MS134S

Code	Poles	Rated Thermal Current (A)	Steps	Enclosure	Key Operated	Quick Installation	Key Operated & Quick Installation With Plate	Lockable Handle With Plate
PSA010MS134S	1 Phase	10	1-0-2	PSK11	✓	✓	✓	✓
PSA016MS134S	1 Phase	16	1-0-2	PSK11	✓	✓	✓	✓
PSA020MS134S	1 Phase	20	1-0-2	PSK11	✓	✓	✓	✓
PSA025MS134S	1 Phase	25	1-0-2	PSK11	✓	✓	✓	✓
PSA032MS134S	1 Phase	32	1-0-2	PSK21				
PSA040MS134S	1 Phase	40	1-0-2	PSK21				
PSA050MS134S	1 Phase	50	1-0-2	PSK31				
PSA063MS134S	1 Phase	63	1-0-2	PSK31				
PSA080MS134S	1 Phase	80	1-0-2	-				
PSA120MS134S	1 Phase	120	1-0-2	-				

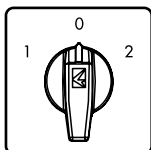

3 Poles Change Over Cam Switches "1-0-2"

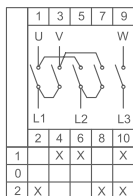

PSA020MS334S

Code	Poles	Rated Thermal Current (A)	Steps	Enclosure	Key Operated	Quick Installation	Key Operated & Quick Installation With Plate	Lockable Handle With Plate
PSA010MS334S	3 Phase	10	1-0-2	PSK12	✓	✓	✓	✓
PSA016MS334S	3 Phase	16	1-0-2	PSK12	✓	✓	✓	✓
PSA020MS334S	3 Phase	20	1-0-2	PSK12	✓	✓	✓	✓
PSA025MS334S	3 Phase	25	1-0-2	PSK12	✓	✓	✓	✓
PSA032MS334S	3 Phase	32	1-0-2	PSK22				
PSA040MS334S	3 Phase	40	1-0-2	PSK22				
PSA050MS334S	3 Phase	50	1-0-2	PSK32				
PSA063MS334S	3 Phase	63	1-0-2	PSK32				
PSA080MS334S	3 Phase	80	1-0-2	-				
PSA120MS334S	3 Phase	120	1-0-2	-				

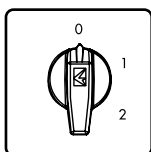

3 Phase Double Cycle Cam Switches (0-1-2)

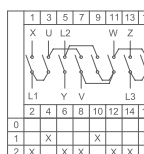

PSA016CD332S

Code	Poles	Rated Thermal Current (A)	Enclosure	Key Operated	Quick Installation	Key Operated & Quick Installation With Plate	Lockable Handle With Plate
PSA010CD332S	3 Phase	10	PSK12	✓	✓	✓	✓
PSA016CD332S	3 Phase	16	PSK12	✓	✓	✓	✓
PSA020CD332S	3 Phase	20	PSK12	✓	✓	✓	✓
PSA025CD332S	3 Phase	25	PSK12	✓	✓	✓	✓
PSA032CD332S	3 Phase	32	PSK22				
PSA040CD332S	3 Phase	40	PSK22				
PSA050CD332S	3 Phase	50	-				
PSA063CD332S	3 Phase	63	-				
PSA080CD332S	3 Phase	80	-				
PSA120CD332S	3 Phase	120	-				

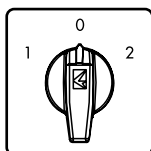

3 Phase Double Cycle Cam Switches (1-0-2)

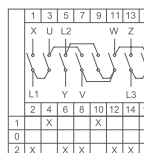

PSA016CD334S

Code	Poles	Rated Thermal Current (A)	Enclosure	Key Operated	Quick Installation	Key Operated & Quick Installation With Plate	Lockable Handle With Plate
PSA010CD334S	3 Phase	10	PSK12	✓	✓	✓	✓
PSA016CD334S	3 Phase	16	PSK12	✓	✓	✓	✓
PSA020CD334S	3 Phase	20	PSK12	✓	✓	✓	✓
PSA025CD334S	3 Phase	25	PSK12	✓	✓	✓	✓
PSA032CD334S	3 Phase	32	PSK22				
PSA040CD334S	3 Phase	40	PSK22				
PSA050CD334S	3 Phase	50	-				
PSA063CD334S	3 Phase	63	-				
PSA080CD334S	3 Phase	80	-				
PSA120CD334S	3 Phase	120	-				

* Can be supplied with Red-Yellow head w/o extra charge, in this case please replace "S" at the end with "E".

** 10-25A Cam Switches can be supplied with big frame (64 x 64) with extra charge, In this case please replace the "S" at the end with "B"

***Please replace "S" letter at the end of the code with "SAQ" for Key Operated & Quick Installation With Plate Model (with extra charge)

**** Please replace "S" letter at the end of the code with "SQ" for Quick Installation model (with extra charge)

Measuring Cam Switches - 45°

Code	Type	Rated Thermal Current (A)	Position	Enclosure	Key Operated	Quick Installation	Key Operated & Quick Installation With Plate	Lockable Handle With Plate
PSA0100K421S	4	10	Voltmeter	PSK11	✓	✓	✓	✓
PSA0160K421S	4	16	Voltmeter	PSK11	✓	✓	✓	✓
PSA0200K421S	4	20	Voltmeter	PSK11	✓	✓	✓	✓
PSA0100K422S	4	10	Phase - Phase Voltmeter	PSK11	✓	✓	✓	✓
PSA0160K422S	4	16	Phase - Phase Voltmeter	PSK11	✓	✓	✓	✓
PSA0200K422S	4	20	Phase - Phase Voltmeter	PSK11	✓	✓	✓	✓
PSA0100K426S	4	10	Ampermeter	PSK12	✓	✓	✓	✓
PSA0160K426S	4	16	Ampermeter	PSK12	✓	✓	✓	✓
PSA0200K426S	4	20	Ampermeter	PSK12	✓	✓	✓	✓
PSA0100K723S	7	10	Voltmeter	PSK12	✓	✓	✓	✓
PSA0160K723S	7	16	Voltmeter	PSK12	✓	✓	✓	✓
PSA0200K723S	7	20	Voltmeter	PSK12	✓	✓	✓	✓

* Please replace "S" letter at the end of the code with "SQ" for Quick Installation model (with extra charge)



PSR1



PSR2



PSMK



PSPK0501



PSK11



PSK12



PSK21



PSK22



PSK31



PSK32

Accessories

Code	Type	Features	Material
PSR1	Rail Mounting Interface	Between 10 - 40 A	Plastic
PSR2	Rail Mounting Interface	Between 50 - 63 A	Plastic
PSMK	Handle Protection Cover	Between 10-25 A	Plastic
PSPK0501	Finger Protection 1 Step	50 A	Plastic
PSPK0502	Finger Protection 2 Step	50 A	Plastic
PSPK0631	Finger Protection 1 Step	63 A	Plastic
PSPK0632	Finger Protection 2 Step	63 A	Plastic

Cam Switch Boxes

Code	Material	Dimensions - Width * Length * Height	Features
PSK11	Plastic	75mm * 85mm * 65mm	IP54
PSK12	Plastic	75mm * 85mm * 90mm	IP54
PSK21	Plastic	91mm * 100mm * 73mm	IP54
PSK22	Plastic	91mm * 100mm * 103mm	IP54
PSK31	Plastic	106mm * 116mm * 86mm	IP54
PSK32	Plastic	106mm * 116mm * 128mm	IP54
PSK11E	Plastic	75mm * 85mm * 65mm	IP65
PSK12E	Plastic	75mm * 85mm * 90mm	IP65
PSK21E	Plastic	91mm * 100mm * 73mm	IP65
PSK22E	Plastic	91mm * 100mm * 103mm	IP65
PSK31E	Plastic	106mm * 116mm * 86mm	IP65
PSK32E	Plastic	106mm * 116mm * 128mm	IP65



PSA020AK131AQ



PSA010KD134SQ



PSA020AK131K



PSA050AK331S + PSPK0502

EBM16PM4K



EBM16FU1T



EBM16PM41



EBP16FU10



EPREU1M



ECE316V4PE



ECE416V5FU



EBP16PM42



ECE416V5PU



EPREU2GL



ECE316V4FU



EBP05PU36



EBP05FU30



EBM04FU30



EB024CF00



EB024CP00



EBM04PM46



Industrial Plugs & Sockets

Plastic Series



EB004CF00



EB004CP00



EBP04FE41



EBP04FU30

4 Poles, 10A (PG 11)

Code	Type	Entry	Handle	Box/Pcs
EB004CF00	Male Insert			100
EB004CP00	Female Insert			100
EBP04FE41*	Sloped Hood with Male Insert	Bottom	Plastic	50
EBP04FU30	Hood with Male Insert	Top		50
EBP05GE41*	Hood for Bulkhead Mounting	Bottom	Plastic	50
EBP05GM41*	Hood for Bulkhead Mounting	Bottom	Plastic	50
EBP05GU30	Hood	Top		50
EBP04PE41*	Sloped Hood with Female Insert	Bottom	Plastic	50
EBP04PM41*	Bulkhead Mounting Female Insert	Bottom	Plastic	50
EBP04PM46*	Bulkhead Mounting Female Insert	Bottom	Metal	50
EBP04PU30	Hood with Female Insert	Top		50
EBP04PU31*	Hood with Female Insert	Top	Plastic	50

5 Poles, 10 A (PG 11)

Code	Type	Entry	Handle	Box/Pcs
EB005CF00	Male Insert			100
EB005CP00	Female Insert			100
EBP05GU30*	Hood	Top		50
EBP05GM41*	Hood for bulkhead mounting	Bottom	Plastic	50
EBP05GE41*	Hood for bulkhead mounting	Bottom	Plastic	50
EBP05FU30*	Hood with Male insert	Top		50
EBP05PU30*	Hood with Female insert	Top		50
EBP05PM41*	Bulkhead mounting, Female insert	Bottom	Plastic	50
EBP05PM46*	Bulkhead Mounting Female Insert	Bottom	Metal	50
EBP05FE41*	Sloped hood with Male insert	Bottom	Plastic	50
EBP05PE41*	Sloped hood with Female insert	Bottom	Plastic	50
EBP05PU31*	Hood with female insert	Top	Plastic	50
EBA05TK	Cap			50

Product is Grey colour. Please add H to end of the code in order to change the colour to Black.
For Metal Handle, replace 1 at the end with 6.



EBP05FU30



EBP05PU30



EBP05PU36



EBP05PE41



EBA05TK



EBP05FU30H



EBP05PM46H



EBP05PM41H

6 Poles, 16 A (PG 16) IP65

Code	Type	Entry	Handle	Box/Pcs
EB006CF00	Male Insert			50
EB006CP00	Female Insert			50
EBP06FM42	Bulkhead mounting, Male insert	Bottom	Plastic	20
EBP06FU10	Hood with Male insert	Side		20
EBP06GM42	Hood for bulkhead mounting	Bottom	Plastic	20
EBP06GU10	Hood	Side		20
EBP06PM42	Bulkhead mounting, Female insert	Bottom	Plastic	20
EBP06PU10	Hood with Female insert	Side		20
EBP06PU12	Hood with Female insert	Side	Plastic	10
EBA06TK	Cap			50



EBP05GE46

10 Poles, 16 A (PG 21) IP65

Code	Type	Entry	Handle	Box/Pcs
EB010CF00	Male Insert			50
EB010CP00	Female Insert			50
EBP10FM42	Bulkhead mounting, Male insert	Bottom	Plastic	20
EBP10FU10	Hood with Male insert	Side		15
EBP10GM42	Hood for bulkhead mounting	Bottom	Plastic	20
EBP10GU10	Hood	Side		15
EBP10GU12	Hood	Side	Plastic	15
EBP10PM42	Bulkhead mounting, Female insert	Bottom	Plastic	20
EBP10PU10	Hood with Female insert	Side		15
EBP10PU12	Hood with Female insert	Side	Plastic	10
EBA10TK	Cap			50



EBP10PM42

NOTE: IP65 Protection Level in combination with appropriate cable gland.



EBP16FU10



EBP16PM42



EBP24FU10



EBP24PM42

16 Poles, 16 A (PG 21) IP65

Code	Type	Entry	Handle	Box/Pcs
EB016CF00	Male Insert			50
EB016CP00	Female Insert			50
EBP16FM42	Bulkhead Mounting Male Insert	Bottom	Plastic	20
EBP16FU10	Hood with Male Insert	Side		15
EBP16GM42	Hood for bulkhead mounting	Bottom	Plastic	20
EBP16GU10	Hood	Side		15
EBP16GU12	Hood	Side	Plastic	15
EBP16PM42	Bulkhead Mounting Female Insert	Bottom	Plastic	20
EBP16PU10	Hood with Female Insert	Side		15
EBP16PU12	Hood with Female Insert	Side	Plastic	10
EBA16TK	Cap			50

24 Poles, 16 A (PG 21) IP65

Code	Type	Entry	Handle	Box/Pcs
EB024CF00	Male Insert			30
EB024CP00	Female Insert			30
EBP24FM42	Bulkhead Mounting Male Insert	Bottom	Plastic	20
EBP24FU10	Hood with Male Insert	Side		15
EBP24GM42	Hood for bulkhead mounting	Bottom	Plastic	20
EBP24GU10	Hood	Side		15
EBP24GU12	Hood	Side	Plastic	15
EBP24PM42	Bulkhead Mounting Female Insert	Bottom	Plastic	20
EBP24PU10	Hood with Female Insert	Side		15
EBP24PU12	Hood with Female Insert	Side	Plastic	10
EBA24TK	Cap			50

Metal Series

4 Poles, 10 A (PG 11)



EBM04FE46



EBM04FU10



EBM04FU30



EBM04PE46



EBM04PM46

Code	Type	Entry	Handle	Box/Pcs
EB004CF00	Male Insert			100
EB004CP00	Female Insert			100
EBM05GU30	Hood	Top		50
EBM05GU36	Hood	Top	Metal	50
EBM05GM46	Hood for bulkhead mounting	Bottom	Metal	50
EBM05GE46	Sloped Hood	Bottom	Metal	50
EBM04FE46	Sloped Hood with Male Insert	Bottom	Metal	50
EBM04FU10	Hood with Male Insert	Side		50
EBM04FU30	Hood with Male Insert	Top		50
EBM04PE46	Sloped Hood with Male Insert	Bottom	Metal	50
EBM04PM46	Bulkhead Mounting Female Insert	Bottom	Metal	50
EBM04PU10	Hood with Female Insert	Side		50
EBM04PU30	Hood with Female Insert	Top		50
EBM04PU36	Hood with Female Insert	Top	Metal	50



EBM04PU10



EBM04PU30



EBM04PU36

NOTE: IP65 Protection Level in combination with appropriate cable gland.

Metal Series

5 Poles, 10 A (PG 11)



EBM05FU30



EBM05PU30



EBM05PU36



EBM05PE41



EBA05TK

Code	Type	Entry	Handle	Box/Pcs
EB005CF00	Male Insert			100
EB005CP00	Female Insert			100
EBM05GU30	Hood	Top		50
EBM05GU36	Hood	Top	Metal	50
EBM05GM46	Hood for bulkhead mounting	Bottom	Metal	50
EBM05GE46	Sloped hood Bottom	Bottom	Metal	50
EBM05FU10	Hood with Male insert	Side		50
EBM05FU30	Hood with Male insert	Top		50
EBM05PU30	Hood with Female insert	Top		50
EBM05PU36	Hood with Female insert	Top	Metal	50
EBM05PM46	Bulkhead mounting, Housing with Female insert	Bottom	Metal	50
EBM05FE46	Sloped hood with Male insert	Bottom	Metal	50
EBM05PE41	Sloped hood with Female insert	Bottom	Plastic	50
EBM05PE46	Sloped hood with Female insert	Bottom	Metal	50
EBM05PU10	Hood with Female insert	Side		50
EBM05PE56	Sloped hood with Female insert	Bottom + Side	Metal	50
EBA05TK	Cap			50

For Plastic handle models, replace "1" instead of "6".



EBM06FU30



EBM06FM42



EBM06PU32



EBM06PU30



EBA06TK

6 Poles, 16 A (PG 16)

Code	Type	Entry	Handle	Box/Pcs
EB006CF00	Male Insert			50
EB006CP00	Female Insert			50
EBM06GU10	Hood	Side		20
EBM06GU30	Hood	Top		20
EBM06GU32	Hood	Top	Metal-Plastic	15
EBM06GM42	Hood for bulkhead mounting	Bottom	Metal-Plastic	20
EBM06FU10	Hood with Male insert	Side		20
EBM06FU30	Hood with Male insert	Top		20
EBM06PU10	Hood with Female insert	Side		20
EBM06PU30	Hood with Female insert	Top		20
EBM06PU32	Hood with Female insert	Top	Metal-Plastic	20
EBM06FM42	Bulkhead mounting, Housing with Male Insert	Bottom	Metal-Plastic	20
EBM06PM42	Bulkhead mounting, Housing with Female Insert	Bottom	Metal-Plastic	20
EBM06PM46	Bulkhead mounting, Housing with Female Insert		Metal-Plastic	20
EBM06FD12	Surface mounting, Housing with Male Insert	Side	Metal-Plastic	15
EBM06PD12	Surface mounting, Housing with Female Insert	Side	Metal-Plastic	15
EBA06TK	Cap			50

* For Metal Handle, replace "2" at the end with "6"



EBM10PU10



EBM10PU30



EBM10FD24



EBM10PM44



EBM10PM47



EBM10PD27



EBA10TK



EBM10PM4K

10 Poles, 16 A (PG 21) IP65

Code	Type	Option	Entry	Handle	Box/Pcs
EB010CF00	Male Insert				50
EB010CP00	Female Insert				50
EBM10GU10	Hood	**	Side		15
EBM10GU30	Hood	**	Top		15
EBM10GU34*	Hood	**	Top	Metal-Plastic	10
EBM10GM44*	Hood for bulkhead mounting		Bottom	Metal-Plastic	20
EBM10GD14*	Surface Mounting Head		Side	Metal-Plastic	10
EBM10GD24*	Surface Mounting Head		Both Side	Metal-Plastic	10
EBM10FU10	Hood with male insert	**	Side		15
EBM10FU30	Hood with male insert	**	Top		15
EBM10PU10	Hood with female insert	**	Side		15
EBM10PU14	Hood with female insert	**	Side	Metal-Plastic	10
EBM10PU30	Hood with female insert	**	Top		15
EBM10PU34*	Hood with female insert	**	Top	Metal-Plastic	10
EBM10FM44*	Bulkhead Mounting, Housing with Male Insert		Bottom	Metal-Plastic	20
EBM10PM44*	Bulkhead Mounting, Housing with Female Insert		Bottom	Metal-Plastic	20
EBM10PM47	Bulkhead mounting, Housing with Female Insert		Bottom	Metal	20
EBM10FD14*	Surface mounting, Housing with Male Insert		Side	Metal-Plastic	10
EBM10FD24*	Surface mounting, Housing with Male Insert		Both Side	Metal-Plastic	10
EBM10PD14*	Surface mounting, Housing with Female Insert		Side	Metal-Plastic	10
EBM10PD24*	Surface mounting, Housing with Female Insert		Both Side	Metal-Plastic	10
EBM10PD27	Surface mounting, Housing with Female Insert		Both Side	Metal-Plastic	10
EBM10TABAN	Base				10
EBA10TK	Cap				50

* For Metal Handle, replace "4" at the end with "7".

* For spring cover preferences, instead of "4" and "7", please use "K" letter.

* Standard PG16, please add PG21 to the end of the code in order to order PG21 hole.

NOTE: IP65 Protection Level in combination with appropriate cable gland.

*Please replace "4" with "1" or "0" with "T" in order to order single handle model.



EB016CP00



EB016CF00



EBM16FU10



EBM16FM44



EBM16PD14



EBM16FD24

16 Poles, 16 A (PG 21) IP65

Code	Type	Entry	Handle	Box/Pcs
EB016CF00	Male Insert			50
EB016CP00	Female Insert			50
EBM16GU10	Hood	Side		10
EBM16GU30	Hood	Top		10
EBM16GU34*	Hood	Top	Metal-Plastic	8
EBM16GM44*	Hood for bulkhead mounting	Bottom	Metal-Plastic	15
EBM16GD14*	Surface mounting hood	Side	Metal-Plastic	8
EBM16GD24*	Surface mounting hood	Both Side	Metal-Plastic	8
EBM16FU10	Hood with male insert	Side		10
EBM16FU30	Hood with male insert	Top		10
EBM16PU10	Hood with female insert	Side		10
EBM16PU14	Hood with female insert	Side	Metal-Plastic	10
EBM16PU30	Hood with female insert	Top		10
EBM16PU34*	Bulkhead Mounting, Housing with Male Insert	Bottom	Metal-Plastic	8
EBM16FM44*	Bulkhead Mounting, Housing with Female Insert	Bottom	Metal-Plastic	15
EBM16PM44*	Surface mounting, Housing with Male Insert	Side	Metal-Plastic	15
EBM16FD14*	Surface mounting, Housing with Male Insert	Both Side	Metal-Plastic	8
EBM16FD24*	Surface mounting, Housing with Female Insert	Side	Metal-Plastic	8
EBM16PD14*	Surface mounting, Housing with Female Insert	Both Side	Metal-Plastic	8
EBM16PD24*	Surface mounting, Housing with female insert	Bottom	Metal-Plastic	8
EBM16PD27	Surface mounting, Housing with female insert	Both Side	Metal-Plastic	8
EBA16TK	Cap			50

* For Metal Handle, replace "4" at the end with "7".

* For spring cover preferences, instead of "4" and "7", please use "K" letter.



EBM16PM4K



EBM24PM4K



EB024CP00



EB024CF00



EBM24FU10



EBM24PM4K



EBM24FD24

24 Poles, 16 A (PG 21)

Code	Type	Entry	Handle	Box/Pcs
EB024CF00	Male Insert			30
EB024CP00	Female Insert			30
EBM24GU10	Hood	Side		10
EBM24GU30	Hood	Top		10
EBM24GU34*	Hood	Top	Metal-Plastic	8
EBM24GM44*	Hood for bulkhead mounting	Bottom	Metal-Plastic	15
EBM24GD14*	Surface mounting hood	Side	Metal-Plastic	8
EBM24GD24*	Surface mounting hood	Both Side	Metal-Plastic	8
EBM24FU10	Hood with male insert	Side		10
EBM24FU30	Hood with male insert	Top		10
EBM24PU10	Hood with female insert	Side		10
EBM24PU14	Hood with female insert	Side	Metal-Plastic	10
EBM24PU30	Hood with female insert	Top		10
EBM24PU34*	Hood with female insert	Top	Metal-Plastic	8
EBM24FM44*	Bulkhead Mounting, Housing with Male Insert	Bottom	Metal-Plastic	15
EBM24PM44*	Bulkhead Mounting, Housing with Female Insert	Bottom	Metal-Plastic	15
EBM24PM47	Bulkhead mounting, Housing with female insert	Bottom	Metal	15
EBM24FD14*	Surface mounting, Housing with Male Insert	Side	Metal-Plastic	8
EBM24FD24*	Surface mounting, Housing with Male Insert	Both Side	Metal-Plastic	8
EBM24PD14*	Surface mounting, Housing with Female Insert	Side	Metal-Plastic	8
EBM24PD24*	Surface mounting, Housing with Female Insert	Both Side	Metal-Plastic	8
EBA24TK	Cap			50

*For Metal Handle, replace "4" at the end with "7". *For spring cover preferences, instead of "4" and "7", please use "K" letter.

*Please add "PG21" to the end of the code in order to order PG21 hole. *NOTE: IP65 Protection Level in combination with appropriate cable gland. *Please replace "4" with "1" or "0" with "T" in order to order single handle model.



EBM24PM44



EBM32FU10



EBM32PU10



EBM32PM44



EBM32FM44



EBA32TK

32 Poles, 16 A (PG 21)

Code	Type	Option	Entry	Handle	Box/Pcs
EB016CF00	Male Insert (1-16)				50
EB016CP00	Female Insert (1-16)				50
EB032CF00	Male Insert (17-32)				30
EB032CP00	Female Insert (17-32)				30
EBM32GU10	Hood	**	Side		6
EBM32GU30	Hood	**	Top		6
EBM32GM44*	Hood for bulkhead mounting		Bottom	Metal-Plastic	10
EBM32GD14*	Surface mounting hood		Side	Metal-Plastic	6
EBM32GD24*	Surface mounting hood		Both Side	Metal-Plastic	6
EBM32FU10	Hood with male insert	**	Side		6
EBM32FU30	Hood with male insert	**	Top		6
EBM32PU10	Hood with female insert	**	Side		6
EBM32PU30	Hood with female insert	**	Top		6
EBM32FM44*	Bulkhead Mounting, Housing with Male Insert		Bottom	Metal-Plastic	10
EBM32PM44*	Bulkhead Mounting, Housing with Female Insert		Bottom	Metal-Plastic	10
EBM32PM48*	Bulkhead Mounting, Housing with Female Insert		Bottom	Metal	10
EBM32FD14*	Surface mounting, Housing with Male Insert		Side	Metal-Plastic	6
EBM32FD24*	Surface mounting, Housing with Male Insert		Both Side	Metal-Plastic	6
EBM32PD14*	Surface mounting, Housing with Female Insert		Side	Metal-Plastic	6
EBM32PD24*	Surface mounting, Housing with Female Insert		Both Side	Metal-Plastic	6
EBM32PU14	Hood with female insert		Side	Metal-Plastic	6
EBM32PU34	Hood with female insert		Top	Metal-Plastic	6
EBM32TABAN	Base				6
EBA32TK	Cap				40

* For Metal Handle, replace "4" at the end with "8". ** Standard PG21, please add PG29 to the end of the code in order to order PG29 hole.

NOTE: IP65 Protection Level in combination with appropriate cable gland.



EBA48TK



EBM48PU10



EBM48FU10



EBM48FU30



EBM48PM44



EBM48PD24

48 Poles, 16 A (PG 29)

Code	Type	Entry	Handle	Box/Pcs
EB024CF00	Male Insert (1-24)			30
EB024CP00	Female Insert (1-24)			30
EB048CF00	Male Insert (25-48)			30
EB048CP00	Female Insert (25-48)			30
EBM48GU10	Hood	Side		4
EBM48GU30	Hood	Top		4
EBM48GM44*	Hood for bulkhead mounting	Bottom	Metal-Plastic	8
EBM48GD14*	Surface mounting hood	Side	Metal-Plastic	4
EBM48GD24*	Surface mounting hood	Both Side	Metal-Plastic	4
EBM48FU10	Hood with male insert	Side		4
EBM48FU30	Hood with male insert	Top		4
EBM48PU10	Hood with female insert	Side		4
EBM48PU30	Hood with female insert	Top		4
EBM48FM44*	Bulkhead Mounting, Housing with Male Insert	Bottom	Metal-Plastic	8
EBM48PM44*	Bulkhead Mounting, Housing with Female Insert	Bottom	Metal-Plastic	8
EBM48PM48*	Bulkhead Mounting, Housing with Female Insert	Bottom	Metal	8
EBM48FD14*	Surface mounting, Housing with Male Insert	Side	Metal-Plastic	4
EBM48FD24*	Surface mounting, Housing with Male Insert	Both Side	Metal-Plastic	4
EBM48PD14*	Surface mounting, Housing with Female Insert	Side	Metal-Plastic	4
EBM48PD24*	Surface mounting, Housing with Female Insert	Both Side	Metal-Plastic	4
EBM48PU14	Hood with female insert	Side	Metal-Plastic	4
EBM48PU34	Hood with female insert	Top	Metal-Plastic	4
EBM48TABAN	Base			4
EBA48TK	Cap			40

* For Metal Handle, replace "4" at the end with "8".



EB0606CP00



EB0606CF00



EBM606FU10



EBM606PD14



EBA16TK

6 Poles, 35 A (PG 21)

Code	Type	Entry	Handle	Box/Pcs
EB0606CF00	Male Insert			50
EB0606CP00	Female Insert			50
EBM16GU10	Hood	Side		10
EBM16GU30	Hood	Top		10
EBM16GU34*	Hood	Top	Metal-Plastic	8
EBM16GM44*	Hood for bulkhead mounting	Bottom	Metal-Plastic	15
EBM16GD14*	Hood for surface mounting	Side	Metal-Plastic	8
EBM16GD24*	Hood for surface mounting	Both Side	Metal-Plastic	8
EBM606FU10	Hood with male insert	Side		10
EBM606FU30	Hood with male insert	Top		10
EBM606PU10	Hood with female insert	Side		50
EBM606PU30	Hood with female insert	Top		10
EBM606PU34*	Hood with female insert	Top	Metal-Plastic	8
EBM606FM44*	Bulkhead Mounting, Housing with Male Insert	Bottom	Metal-Plastic	15
EBM606PM44*	Bulkhead Mounting, Housing with Female Insert	Bottom	Metal-Plastic	15
EBM606FD14*	Surface mounting, Housing with Male Insert	Side	Metal-Plastic	8
EBM606FD24*	Surface mounting, Housing with Male Insert	Both Side	Metal-Plastic	8
EBM606PD14*	Surface mounting, Housing with Female Insert	Side	Metal-Plastic	8
EBM606PD24*	Surface mounting, Housing with Female Insert	Both Side	Metal-Plastic	8
EBA16TK	Cap			50

* For Metal Handle, replace "4" at the end with "7".

* For spring cover preferences, instead of "4" and "7", please use "K" letter.

* Please add "PG21" to the end of the code in order to order PG21 hole.

* NOTE: IP65 Protection Level in combination with appropriate cable gland.

* Please replace "4" with "1" or "0" with "T" in order to order single handle model.



EBM612PU10



EBM612PM44



EBA32TK

12 Poles, 35 A (PG 21) IP65

Code	Type	Entry	Handle	Box/Pcs
EB0606CF00	Male Insert (1-6)			50
EB0606CP00	Female Insert (1-6)			50
EB0612CF00	Male Insert (7-12)			50
EB0612CP00	Female Insert (7-12)			50
EBM32GU10	Hood	Side		6
EBM32GU30	Hood	Top		6
EBM32GM44*	Hood for bulkhead mounting	Bottom	Metal-Plastic	10
EBM32GD14*	Hood for surface mounting	Side	Metal-Plastic	6
EBM32GD24*	Hood for surface mounting	Both Side	Metal-Plastic	6
EBM612FU10	Hood with male insert	Side		6
EBM612FU30	Hood with male insert	Top		6
EBM612PU10	Hood with female insert	Side		6
EBM612PU30	Hood with female insert	Top		6
EBM612FM44*	Bulkhead Mounting, Housing with Male Insert	Bottom	Metal-Plastic	10
EBM612PM44*	Bulkhead Mounting, Housing with Female Insert	Bottom	Metal-Plastic	10
EBM612FD14*	Surface mounting, Housing with Male Insert	Side	Metal-Plastic	6
EBM612FD24*	Surface mounting, Housing with Male Insert	Both Side	Metal-Plastic	6
EBM612PD14*	Surface mounting, Housing with Female Insert	Side	Metal-Plastic	6
EBM612PD24*	Surface mounting, Housing with Female Insert	Both Side	Metal-Plastic	6
EBA32TK	Cap			40

* For Metal Handle, replace "4" at the end with "8".



EB0806CF00



EB0806CP00



EBM806FU10



EBM806PD14



EBA16TK

6 Poles (4 x 80A + 2 x 16A) (PG21) IP65

Code	Type	Entry	Handle	Box/Pcs
EB0806CF00	Male Insert			50
EB0806CP00	Female Insert			40
EBM16GU10	Hood	Side		10
EBM16GU30	Hood	Top		10
EBM16GU34*	Hood	Top	Metal-Plastic	8
EBM16GM44*	Hood for bulkhead mounting	Bottom	Metal-Plastic	15
EBM16GD14*	Hood for surface mounting	Side	Metal-Plastic	8
EBM16GD24*	Hood for surface mounting	Both Side	Metal-Plastic	8
EBM806FU10	Hood with male insert	Side		10
EBM806FU30	Hood with male insert	Top		10
EBM806FM44*	Bulkhead mounting, housing with male insert with 4 roller handle	Bottom	Metal-Plastic	15
EBM806FD14*	Surface mounting, housing with male insert	Side	Metal-Plastic	8
EBM806FD24*	Surface mounting, housing with male insert	Both Side	Metal-Plastic	8
EBM806PM44*	Bulkhead mounting, housing with female insert with 4 roller handle	Bottom	Metal-Plastic	15
EBM806PU10	Hood with female insert	Side		10
EBM806PU30	Hood with female insert	Top		10
EBM806PD14*	Surface mounting, housing with male insert	Side	Metal-Plastic	8
EBM806PD24*	Surface mounting, housing with female insert	Both Side	Metal-Plastic	8
EBA16TK	Cap			50

* For Metal Handle, replace "4" at the end with "7".

NOTE: IP65 Protection Level in combination with appropriate cable gland.

*For spring cover preferences, instead of "4" and "7", please use "K" letter.

*Please add "PG21" to the end of the code in order to order PG21 hole.

*Please replace "4" with "1" or "0" with "T" in order to order single handle model.



EBM812FU30



EBM812PM44



EBA32TK

12 Poles, 2 x (4 x 80A + 2 x 16A) (PG 21)

Code	Type	Entry	Handle	Box/Pcs
EB0806CF00	Male Insert (1-6)			50
EB0806CP00	Female Insert (1-6)			50
EB0812CF00	Male Insert (7-12)			50
EB0812CP00	Female Insert (7-12)			50
EBM812FU10	Hood with male insert	Side		6
EBM812FU30	Hood with male insert	Top		6
EBM812FM44*	Bulkhead Mounting, Housing with Male Insert with 4 Roller Handle	Bottom	Metal-Plastic	8
EBM812PM44*	Bulkhead Mounting, Housing with Female Insert with 4 Roller Handle	Bottom	Metal-Plastic	10
EBM812FD14*	Surface mounting, Housing with Male Insert	Side	Metal-Plastic	6
EBM812FD24*	Surface mounting, Housing with Male Insert	Both Side	Metal-Plastic	6
EBM812PD14*	Surface mounting, Housing with Female Insert	Side	Metal-Plastic	6
EBM812PD24*	Surface mounting, Housing with Female Insert	Both Side	Metal-Plastic	6
EBM812PU10	Hood with male insert	Side		6
EBM812PU30	Hood with female insert	Top		6
EBA32TK	Cap			40

* For Metal Handle, replace "4" at the end with "8".

NOTE: IP65 Protection Level in combination with appropriate cable gland.



EBMKE



EBMKD

Accessories

Code	Features	Box/Pcs
EBMKD	Marking Pin - Female	10
EBMKE	Marking Pin - Male	10



EPREU1M



EPRUS1H

Panel Type Sockets

Code	Features	Colour	Box/Pcs
EPREU1M	European Schuko Type 1		40
EPRUS1H	American, Type1		40
EPREU2G	Rail Types		10
EPREU2GL	Rail Types, with LED		10
EPRFR2K	Panel Socket, UPS Socket (French Type)		10
EPRFR2G	Rail Type, UPS Socket (French Type)		10



EPREU2G



EPRFR2K



EPREU2GL



EKS116P



EKS325PG30

Rubber Type Plugs & Sockets

Code	Type	Features	Box/Pcs
EKS116F	Plug	1 x 16 A	40
EKS116P	Socket	1 x 16 A	30
EKS116PG1	Wall Socket	1 x 16 A	20
EKS116PG3	Group Socket - 3 Way	3x (1 x 16 A)	6
EKS325F	Plug	3 x 25 A	30
EKS325PG30	Group Socket - 3 Way	3 x (3 x 25) A	4
EKS325PG21	Group Socket - 3 Way	2 x (3x25) A + 1 x (1x16) A	4
EKS325PG12	Group Socket - 3 Way	1 x (3x25) A + 2 x (1x16) A	4



EKS116PG3



EKS325F



EKS116F



EKS116PG1

ECE Series CEE NORM

3 x 16 A (2P+E) IP44

Code	Type	Option	Voltage	Box/Pcs
ECE316V4FU	Hood with Male Insert	Screw Terminal	220/240V AC	15
ECE316V4PE	Sloped hood with Female insert	Screw Terminal	220/240V AC	15
ECE316V4PM	Bulkhead mounting, Housing with Female Insert	Screw Terminal	220/240V AC	15
ECE316V4PU	Hood with Female Insert	Screw Terminal	220/240V AC	15



ECE316V4FU



ECE316V4PE



ECE316V4PE



ECE316V4PM



ECE316V4PM



ECE316V4PU



ECE316V4PU

4 x 16 A (3P+E) IP44

Code	Type	Option	Voltage	Box/Pcs
ECE416V5FU	Hood with Male Insert	Screw Terminal	380/480V AC	15
ECE416V5PE	Sloped hood with Female insert	Screw Terminal	380/480V AC	15
ECE416V5PM	Bulkhead mounting, Housing with Female Insert	Screw Terminal	380/480V AC	15
ECE416V5PU	Hood with Female Insert	Screw Terminal	380/480V AC	12



ECE416V5FU



ECE416V5PE



ECE416V5PE



ECE416V5PM



ECE416V5PM



ECE416V5PU



ECE416V5PU



IF6P024WM05

IF5T024ZM05



IF5M024XM05



IT070R240Z

IK53F024ZM03



IF3P024XS30-1



IKML110Y



IT120G024Z



IT120Y024

Signalling Devices

IK Series

Light Towers can be purchased as complete or modular. Mounting system is easy with plug and turn system without any mounting equipment.

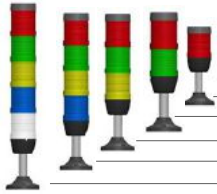

COMPLETE LIGHT TOWER Dia 50 mm (with 100 mm Aluminium connection, body and Lamps)

Code	Illumination	Buzzer
IK51L * XM03	LED	-
IK52L * XM03	LED	-
IK53L * XM03	LED	-
IK54L * XM03	LED	-
IK55L * XM03	LED	-

Code	Illumination	Buzzer
IK51F * XM03	with Flashing LED	-
IK52F * XM03	with Flashing LED	-
IK53F * XM03	with Flashing LED	-
IK54F * XM03	with Flashing LED	-
IK55F * XM03	with Flashing LED	-



Code	Illumination	Buzzer
IK50X * ZM03	-	90 dB
IK51L * ZM03	LED	90 dB
IK52L * ZM03	LED	90 dB
IK53L * ZM03	LED	90 dB
IK54L * ZM03	LED	90 dB

Code	Illumination	Buzzer
IK50X * ZM03	-	90 dB
IK51F * ZM03	with Flashing LED	90 dB
IK52F * ZM03	with Flashing LED	90 dB
IK53F * ZM03	with Flashing LED	90 dB
IK54F * ZM03	with Flashing LED	90 dB

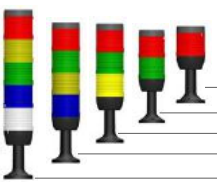

COMPLETE LIGHT TOWER Dia 70 mm (100 mm Plastic connection, body and Lamps)

Code	Illumination	Buzzer
IK71L * XM01	LED	-
IK72L * XM01	LED	-
IK73L * XM01	LED	-
IK74L * XM01	LED	-
IK75L * XM01	LED	-

Code	Illumination	Buzzer
IK71F * XM01	with Flashing LED	-
IK72F * XM01	with Flashing LED	-
IK73F * XM01	with Flashing LED	-
IK74F * XM01	with Flashing LED	-
IK75F * XM01	with Flashing LED	-

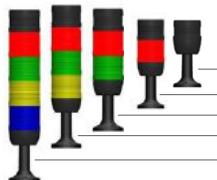

Code	Illumination	Buzzer
IK70X * ZM01	-	90 dB
IK71L * ZM01	LED	90 dB
IK72L * ZM01	LED	90 dB
IK73L * ZM01	LED	90 dB
IK74L * ZM01	LED	90 dB

Code	Illumination	Buzzer
IK70X * ZM01	-	90 dB
IK71F * ZM01	with Flashing LED	90 dB
IK72F * ZM01	with Flashing LED	90 dB
IK73F * ZM01	with Flashing LED	90 dB
IK74F * ZM01	with Flashing LED	90 dB

* Shows the voltage of the LED. When it is written "024", it means that it is 24V AC/DC, when written "220" it is 220VAC, "110" it is 110V AC. For IP65 please add E letter to the end of the code. (Excluding buzzer versions)

Each Light Tower consists of below components.

1. Body and Cover
2. Signal Modules (5 Colour)
3. Buzzer module
4. LED, Flashing LED
5. Connection

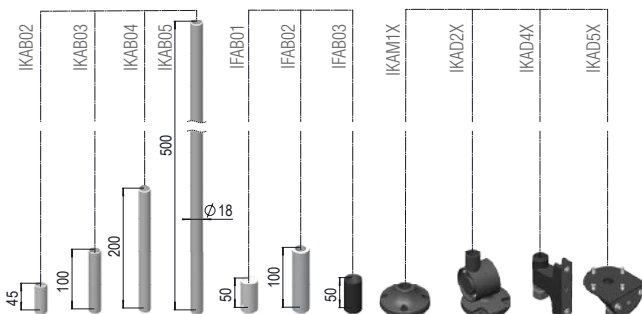
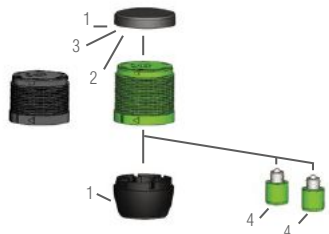

MODULES

1-Body and Cover

IKM5G Dia 50 mm

* Maximum up to 5 modules can be mounted



1-Body and Cover

IKM7G Dia 70mm

* Maximum up to 5 modules can be mounted



2- Signal Modules

IKM5* 50 mm

Heat resistant polycarbonate material
(*) B M S Y K



2- Signal Modules

IKM7* 70 mm

Heat resistant polycarbonate material
(*) B M S Y K



3- Buzzer Modules

IKM5Z024
50 mm / 90 dB
IKM5Z110
50 mm / 90 dB
IKM5Z220
50 mm / 90 dB



3- Buzzer Modules

IKM7Z024
70 mm / 90 dB
IKM7Z110
70 mm / 90 dB
IKM7Z220
70 mm / 90 dB



4- Lamps

Nominal Voltage	with LED	Colour
24V AC/DC	IKML024*	(B) (K) (Y) (S) (M)
110V AC	IKML110*	(B) (K) (Y) (S) (M)
220V AC	IKML220*	(B) (K) (Y) (S) (M)

Nominal Voltage	with Flashing LED	Colour
24V AC/DC	IKMF024*	(B) (K) (Y) (S) (M)
110V AC	IKMF110*	(B) (K) (Y) (S) (M)
220V AC	IKMF220*	(B) (K) (Y) (S) (M)

Please choose the color instead of (*) i.e. IKML024Y
Note. One lamp should be added for each Signal module.



IKML024K



IKML110Y



IKML220M



IKMF024S

IK General Mounting

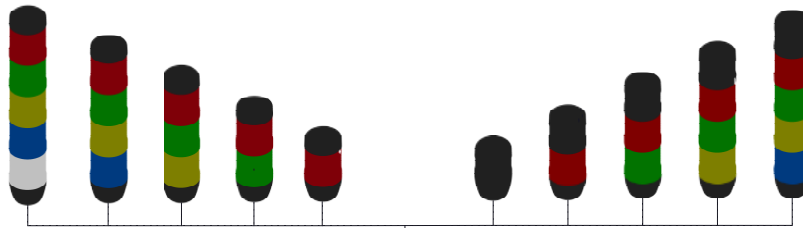

IK5****X***

IK5****Z*** (With Buzzer)

Instead of "xxx" end of the page, write down three letter of below codes.

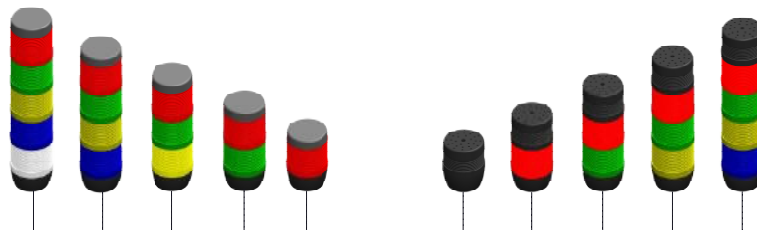
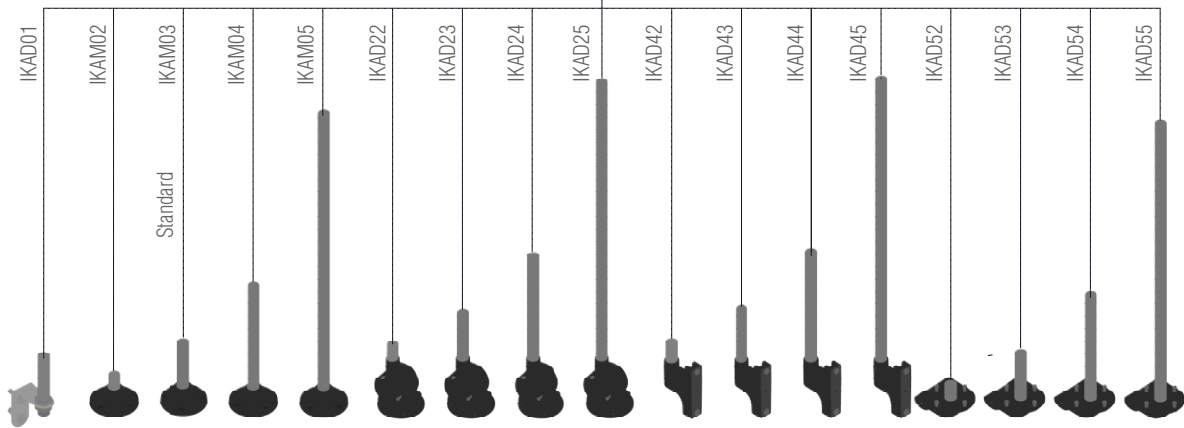

IK7****X***

IK7****Z*** (With Buzzer)

Instead of "xxx" end of the page, write down three letter of below codes.

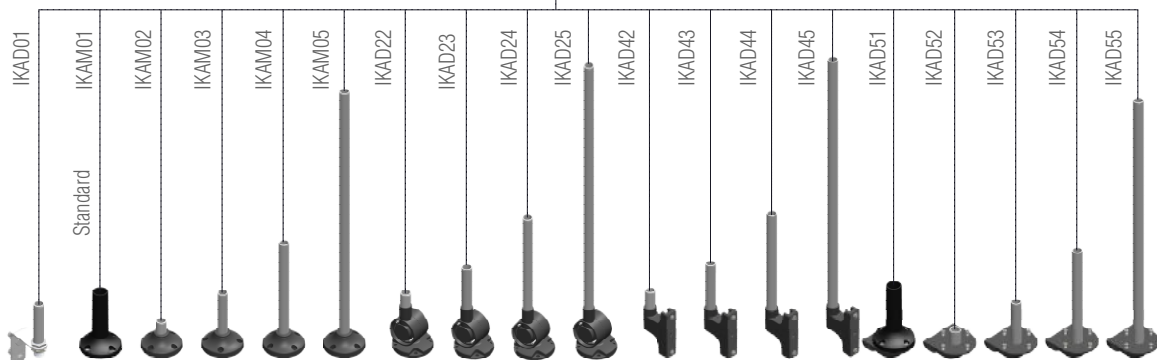

IF Series Multi Colour Beacons with Ø 22 mm connection, IP65



IF Series

- Single body, multi colour
- Ø22 mm Connection
- Flashing and normal LED mode available in same module.
- 90 dB Buzzer



IF3P0240S30-1



IF3P024MS30-1



IF5T024ZM05



IF5M220ZM05



IF6P024WM05

Code	Illumination	Features	Nominal Voltage	Box/Pcs
IF3P0240S30-1	LED	Without Buzzer, Diamond Shape, 5 Colours, for PNP Application	24V DC	1
IF3N0240S30-1	LED	Without Buzzer, Diamond Shape, 5 Colours, for NPN Application	24V DC	1
IF3P024MS30-1	LED	Without Buzzer, Round Shape, 5 Colours, for PNP Application	24V DC	1
IF3N024MS30-1	LED	Without Buzzer, Round Shape, 5 Colours, for NPN Application	24V DC	1
IF5*024XM05	LED	Single Colour	24V AC/DC	1
IF5*024XM05	LED	Single Colour, Rotational	24V AC/DC	1
IF5*024ZM05	LED	Single Colour, With Buzzer	24V AC/DC	1
IF5*024ZM05	LED	Single Colour, With Buzzer, Rotational	24V AC/DC	1
IF5*220XM05	LED	Single Colour	220V AC	1
IF5*220XM05	LED	Single Colour, Rotational	220V AC	1
IF5*220ZM05	LED	Single Colour, With Buzzer	220V AC	1
IF5*220ZM05	LED	Single Colour, With Buzzer, Rotational	220V AC	1
IF5M012XM05	LED	5 Colours	12V AC/DC	1
IF5M012ZM05	LED	5 Colours, With Buzzer	12V AC/DC	1
IF5M024XM05	LED	5 Colours	24V AC/DC	1
IF5M024ZM05	LED	5 Colours, With Buzzer	24V AC/DC	1
IF5M110XM05	LED	5 Colours	110V AC	1
IF5M110ZM05	LED	5 Colours, With Buzzer	110V AC	1
IF5M220XM05	LED	5 Colours	220V AC	1
IF5M220ZM05	LED	5 Colours, With Buzzer	220V AC	1
IF5P024XM05	LED	Single Module 5 Colours, for PNP application	24V DC	1
IF5P024ZM05	LED	Single Module 5 Colours, for PNP application, with Buzzer	24V DC	1
IF5N024XM05	LED	Single Module 5 Colours, for NPN application	24V DC	1
IF5N024ZM05	LED	Single Module 5 Colours for NPN application, with Buzzer	24V DC	1
IF5T024XM05	LED	3 Layers in Single Body, 3 Colours, PLC Harmonized	24V DC	1
IF5T024ZM05	LED	3 Layers in Single Body, 3 Colours, PLC Harmonized+with Buzzer	24V DC	1
IF6P024WM05	LED	PLC Harmonized, 5 Colours, with Self-Adjusted Buzzer**	24V DC	1

Note: For base options, please choose metal bases from page 70. Should be used with IFAB01 or IFAB03.

* Single Colour

** If the environment noise is less than 80dB the beacon will sound at 90dB. If the environment noise is greater than 80dB the beacon automatically changes the sound to 105dB.

R: Red, G: Green, Y: Yellow, B: Blue, W: White

IF General Mounting

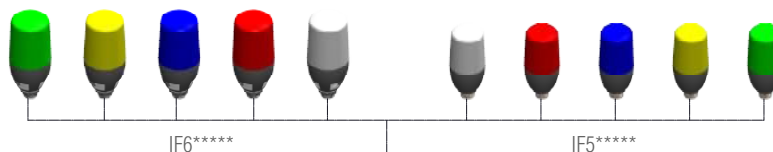

Instead of "xxx" end of the page, write down three letter of below codes.

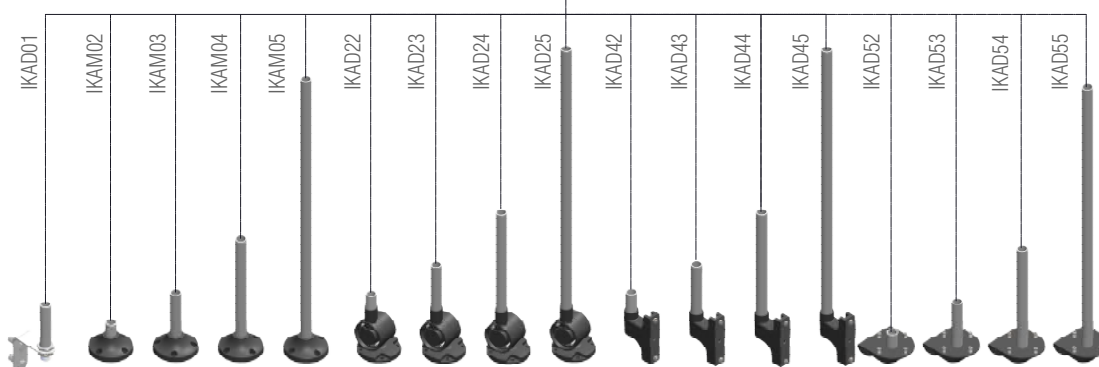
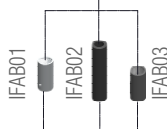

IF and IK Series Mounting Options IP 65

Code	Features
IKAM01	100 mm Plastic base
IKAM1X	Connection to base
IKAM02	Connection to base with 10 mm tube
IKAM03	Connection to base with 100 mm tube
IKAM04	Connection to base with 200 mm tube
IKAM05	Connection to base with 500 mm tube
IKAD01	Wall Connection, 100 mm Aluminium tube
IKAD2X	Adjustable wall elbow
IKAD22	Adjustable Wall Elbow with 10 mm tube
IKAD23	Adjustable Wall Elbow with 100 mm tube
IKAD24	Adjustable Wall Elbow with 200 mm tube
IKAD25	Adjustable Wall Elbow with 500 mm tube
IKAD4X	Wall connection with - Bottom Entry (with cable gland)
IKAD42	Wall connection, bottom entry (with cable gland) with 10 mm tube
IKAD43	Wall connection, bottom entry (with cable gland) with 100 mm tube
IKAD44	Wall connection, bottom entry (with cable gland) with 200 mm tube
IKAD45	Wall connection, bottom entry (with cable gland) with 500 mm tube
IKAD5X	Wall connection with base - Bottom Entry (with cable gland)
IKAD52	Wall connection, bottom entry (with cable gland) with 10 mm tube
IKAD53	Wall connection, bottom entry (with cable gland) with 100 mm tube
IKAD54	Wall connection, bottom entry (with cable gland) with 200 mm tube
IKAD55	Wall connection, bottom entry (with cable gland) with 500 mm tube
IKAB02	45 mm tube
IKAB03	100 mm tube
IKAB04	200 mm tube
IKAB05	500 mm tube
IFAB01	Base Adaptation Part (50mm)
IFAB02	Base Adaptation Part (100mm)
IFAB03	Base Adaptation Part-Black (100 mm)



IFAB01



IFAB03



IKAM02



IKAD22

IF Series Multi Colour Beacons with $\varnothing 22$ mm Connection, IP65

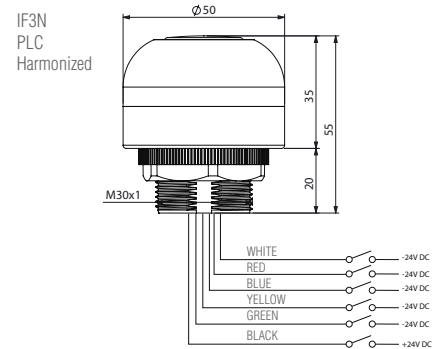
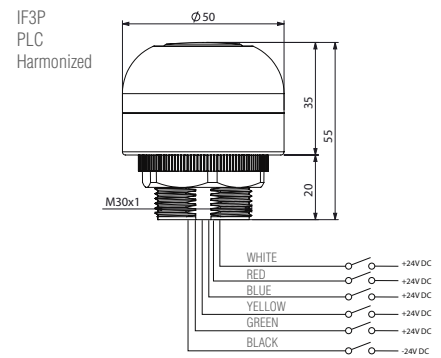
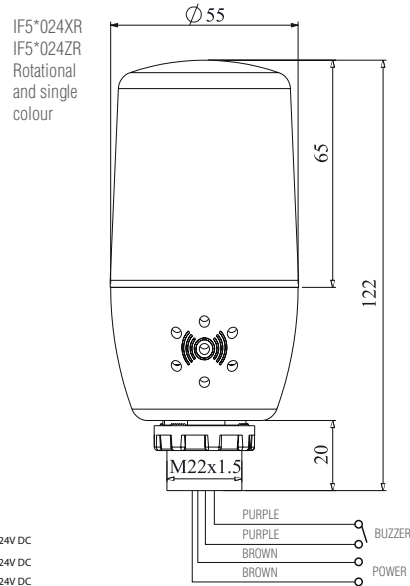
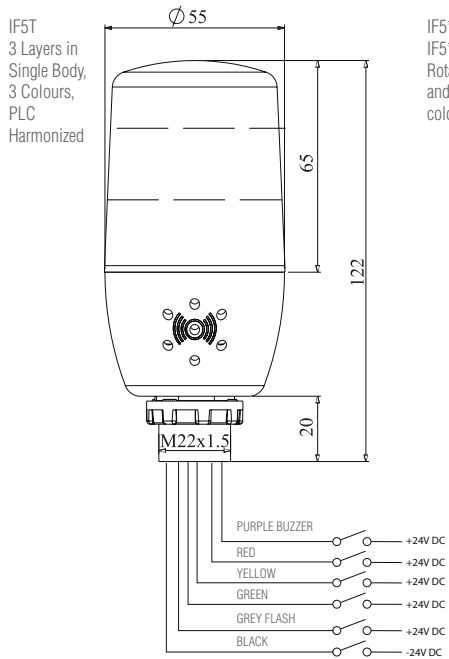
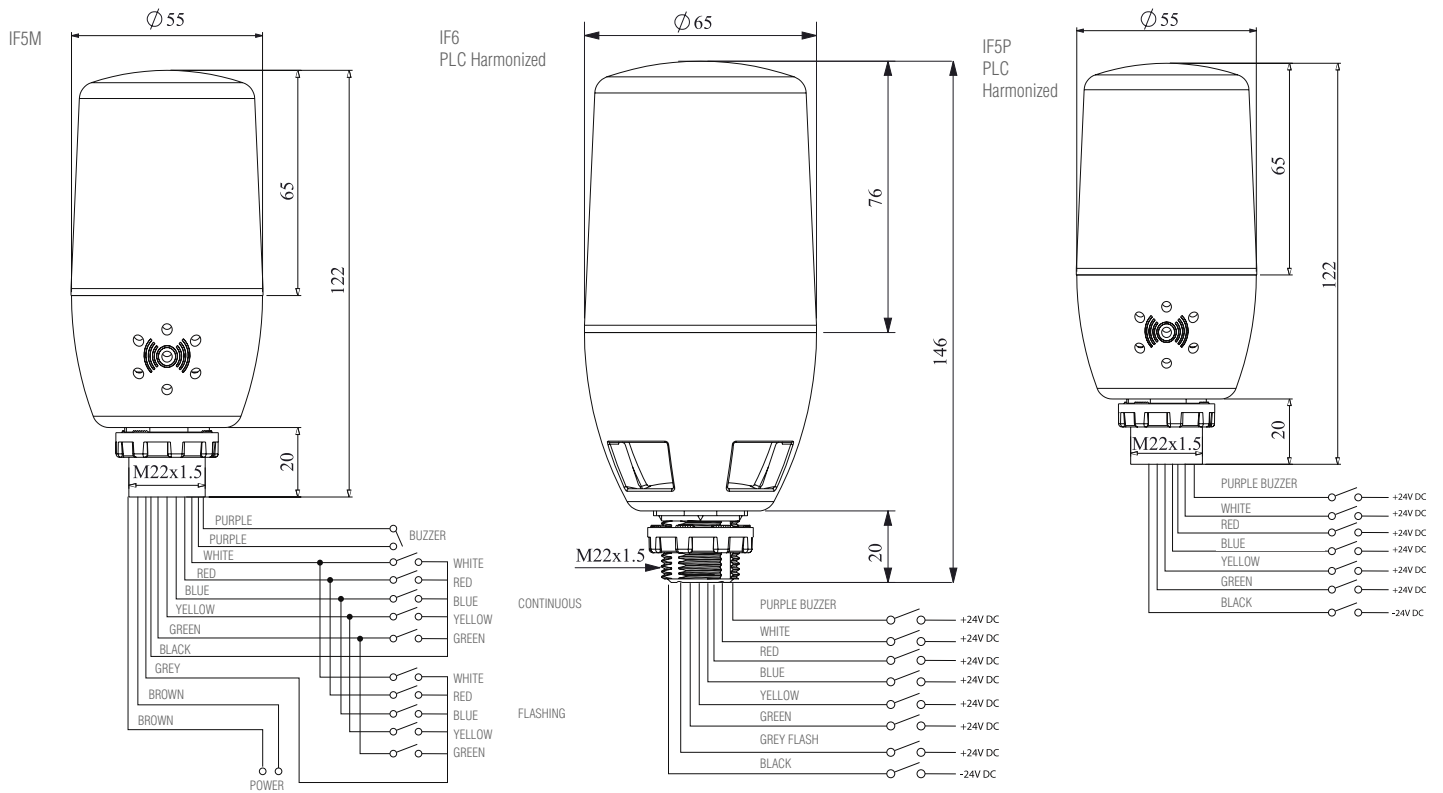

IT Series, IP65



IT120R024

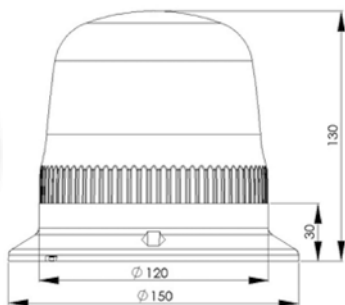

IT120R024Z

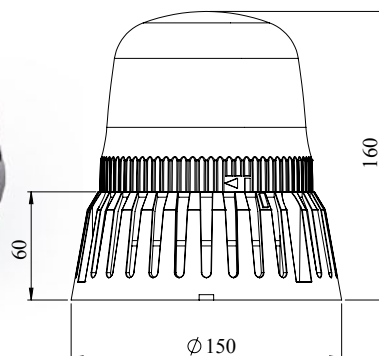

Beacon

General Specification;

- Fireproof plastic body
- Polycarbonate lens
- Base and wall-mount
- Unaffected by water, dust, heat and UV.
- Wear-free due to the absence of moving components
- Long life
- Melody and Silent mode. (for Buzzer models)
- 7 LED modes
- IP 65 rating

Technical Specification;

- Operating Voltage: 12-24V AC/DC, 48-110- 220V AC,
- Current consumption: 3,4W (at 24 V DC by rotating mode)
- Operating temperature: -20 / +50 C°
- Storage temperature: -20 / +70 C°
- 105dB Buzzer

Modes

- Rotation 100 RPM :
- Rotation 160 RPM :
- Single Blink
- 3 Blink
- 6 Blink
- Right-Left Blink
- Blinker



IT070R024Z

Code	Light	Colour	Features	Voltage	Box/Pcs
IT070R024Z	Led	R	With Buzzer	12-24V AC/DC	1
IT070R240Z	Led	R	With Buzzer	48-240V AC/DC	1
IT070Y024Z	Led	Y	With Buzzer	12-24V AC/DC	1
IT070Y240Z	Led	Y	With Buzzer	48-240V AC/DC	1
IT070G024Z	Led	G	With Buzzer	12-24V AC/DC	1
IT070G240Z	Led	G	With Buzzer	48-240V AC/DC	1
IT070R024C	Led	R	Buzzer Enable	12-24V AC/DC	1
IT070R230C	Led	R	Buzzer Enable	230V AC	1
IT120R024	Led	R		12-24V AC/DC	1
IT120R024Z	Led	R	With Buzzer	12-24V AC/DC	1
IT120R048	Led	R		48V AC	1
IT120R220	Led	R		110-220V AC	1
IT120R220Z	Led	R	With Buzzer	110-220V AC	1
IT120Y024	Led	Y		12-24V AC/DC	1
IT120Y024Z	Led	Y	With Buzzer	12-24V AC/DC	1
IT120Y048	Led	Y		48V AC	1
IT120Y220	Led	Y		110-220V AC	1
IT120Y220Z	Led	Y	With Buzzer	110-220V AC	1
IT120G024	Led	G		12-24V AC/DC	1
IT120G024Z	Led	G	With Buzzer	12-24V AC/DC	1
IT120G048	Led	G		48V AC	1
IT120G220	Led	G		110-220V AC	1
IT120G220Z	Led	G	With Buzzer	110-220V	1

Note: Please add "C" letter at the end of the code in order to have buzzer as optional for *IT070 type beacons.



SSY11



MKS1TM-0.40



TSP-1,6



MKS1-KES

Motor Protection Circuit Breakers



MKS1TM-0.40

Thermic & Magnetic Protection

Code	Current Calibration Interval (A)	Fuse Selection Table (A)				Switching Capacity (kA)				Box/Pcs
		230V	400V	500V	690V	230V	400V	500V	690V	
MKS1TM-0.16	0.10 - 0.16	-	-	-	-	100	100	100	100	1
MKS1TM-0.25	0.16 - 0.25	-	-	-	-	100	100	100	100	1
MKS1TM-0.40	0.25 - 0.40	-	-	-	-	100	100	100	100	1
MKS1TM-0.63	0.40 - 0.63	-	-	-	-	100	100	100	100	1
MKS1TM-1	0.63 - 1.00	-	-	-	-	100	100	100	100	1
MKS1TM-1.6	1.00 - 1.60	-	-	-	-	6	6	3	2,5	1
MKS1TM-2.5	1.60 - 2.50	-	-	25	20	6	6	3	2,5	1
MKS1TM-4	2.50 - 4.00	-	-	35	25	6	6	3	2,5	1
MKS1TM-6.3	4.00 - 6.30	-	-	50	35	6	6	2,5	2	1
MKS1TM-10	6.30 - 10.0	-	80	50	35	6	6	2,5	2	1
MKS1TM-16	10.0 - 16.0	80	80	63	35	6	6	2,5	2	1
MKS1TM-20	16.0 - 20.0	80	80	63	50	6	6	2,5	2	1
MKS1TM-25	20.0 - 25.0	80	80	63	50	6	6	2,5	2	1

Thermic & Magnetic Protection Boxes



MKS1-K

MKS-Box Type

Code	Current Calibration Interval (A)	Mounting	Button Case	Box/Pcs
MKS1TMK-0.16	0.10 - 0.16	Surface	IP65	1
MKS1TMK-0.25	0.16 - 0.25	Surface	IP65	1
MKS1TMK-0.40	0.25 - 0.40	Surface	IP65	1
MKS1TMK-0.63	0.40 - 0.63	Surface	IP65	1
MKS1TMK-1	0.63 - 1.00	Surface	IP65	1
MKS1TMK-1.6	1.00 - 1.60	Surface	IP65	1
MKS1TMK-2.5	1.60 - 2.50	Surface	IP65	1
MKS1TMK-4	2.50 - 4.00	Surface	IP65	1
MKS1TMK-6.3	4.00 - 6.30	Surface	IP65	1
MKS1TMK-10	6.30 - 10.0	Surface	IP65	1
MKS1TMK-16	10.0 - 16.0	Surface	IP65	1
MKS1TMK-20	16.0 - 20.0	Surface	IP65	1
MKS1TMK-25	20.0 - 25.0	Surface	IP65	1



MKS1-KES

Accessories

Code	Type	Features	Box/Pcs
MKS1-K	MKS Box	Empty	1
MKS1-KE	MKS Box	With Emergency Stop Button	1
MKS1-KES	MKS Box	With Emergency Stop Button and Signal	1
MKS1-YKD00	Auxiliary Contact	2 NC	4
MKS1-YKD01	Auxiliary Contact	1 NO + 1 NC	4
MKS1-YKD11	Auxiliary Contact	2 NO	4
MKS1-DGR-4	Undervoltage Release	110V	1
MKS1-DGR-5	Undervoltage Release	220V	1
MKS1-DGR-6	Undervoltage Release	400V	1
MKS1-AR-5	Shunt Release	220V	1
MKS1-AR-6	Shunt Release	400V	1



MKS1-YKD00



MKS1-DGR-5



SSY11

Cylindrical Fuse Housing

Code	Number of Poles	Cylindrical Fuse(mm)	Box/Pcs
SSY11	1P	10 x 38	10
SSY11N	1P+N	10 x 38	5
SSY12	2P	10 x 38	5
SSY13	3P	10 x 38	3
SSY13N	3P+N	10 x 38	3

Thermic Protection



TSP-0.32

TSP-with Box				
Code	Current Calibration Interval (A)	Mounting	Protection	Box/Pcs
TSP-0.32	0.18 - 0.32	Surface	IP65	1
TSP-0.55	0.30 - 0.55	Surface	IP65	1
TSP-0.70	0.40 - 0.70	Surface	IP65	1
TSP-1.00	0.60 - 1.00	Surface	IP65	1
TSP-1.60	0.90 - 1.60	Surface	IP65	1
TSP-2.50	1.50 - 2.50	Surface	IP65	1
TSP-3.50	2.40 - 3.50	Surface	IP65	1
TSP-5.50	3.20 - 5.50	Surface	IP65	1
TSP-8.50	5.00 - 8.50	Surface	IP65	1
TSP-13.0	8.00 - 13.00	Surface	IP65	1
TSP-16.0	11.00 - 16.00	Surface	IP65	1



TSG-0.32

TSG-Flush Type				
Code	Current Calibration Interval (A)	Mounting	Protection	Box/Pcs
TSG-0.32	0.18 - 0.32	Flush	IP65	1
TSG-0.55	0.30 - 0.55	Flush	IP65	1
TSG-0.70	0.40 - 0.70	Flush	IP65	1
TSG-1.00	0.60 - 1.00	Flush	IP65	1
TSG-1.60	0.90 - 1.60	Flush	IP65	1
TSG-2.50	1.50 - 2.50	Flush	IP65	1
TSG-3.50	2.40 - 3.50	Flush	IP65	1
TSG-5.50	3.20 - 5.50	Flush	IP65	1
TSG-8.50	5.00 - 8.50	Flush	IP65	1
TSG-13.0	8.00 - 13.00	Flush	IP65	1
TSG-16.0	11.00 - 16.00	Flush	IP65	1



SKF

Level Control Float Switches



SKF

Cobra		
Code	Poles	Cable Length (m)
SKF-0.5	1	0,50
SKF	1	1,75
SKF-3	1	3
SKF-5	1	5
SKF-10	1	10
SKF-15	1	15
SKF-20	1	20
SKF-35	1	35



SKF1A

Bulb		
Code	Poles	Cable Length (m)
SKF1A-1*	1	1
SKF1A*	1	1,75
SKF1A-3*	1	3
SKF1A-5*	1	5
SKF1A-10*	1	10
SKF1A-15*	1	15
SKF1A-20*	1	20
SKF1A-30*	1	30

* For Neoprene cable, please add "N" letter to end of the code (Please ask prices)



SK5P

Switch Actuated		
Code	Remote Control	Stainless Float
SK5P	√	

HJ12X09UB



HNY11



HJ11A09UG

Contactors

HN Series Contactors



HN0901NU



HN1301NU



HN40NU

Code	Rated Current (A) 380V AC3	Rated Thermal Current (A) I _{th}	Auxiliary Contacts	Power (kW)			Box/Pcs
				220-240V	380-415V	660V	
HN0901N*	9	20	1 NC	2,2	4	4,5	1
HN0910N*	9	20	1 NO	2,2	4	4,5	1
HN1301N*	13	20	1 NC	3,2	6	6,5	1
HN1310N*	13	20	1 NO	3,2	6	6,5	1
HN1701N*	17	30	1 NC	4	7,5	8,5	1
HN1710N*	17	30	1 NO	4	7,5	8,5	1
HN2501N*	25	30	1 NC	6	11	12,5	1
HN2510N*	25	30	1 NO	6	11	12,5	1
HN33N*	33	45		7,5	15	18,5	1
HN40N*	40	45		11	22	30	1



HNMK1



HNYU22



HNYYB11

Accessories

Code	Features	Contact Block	Box/Pcs
HNMK1	9-13 A Mechanical Interlock		1
HNYU04	9-65 A Auxiliary Contact Block	4 NC	1
HNYU40	9-65 A Auxiliary Contact Block	4 NO	1
HNYU13	9-65 A Auxiliary Contact Block	1 NO + 3 NC	1
HNYU31	9-65 A Auxiliary Contact Block	3 NO + 1 NC	1
HNYU22	9-65 A Auxiliary Contact Block	2 NO + 2 NC	1
HNYU20	9-65 A Auxiliary Contact Block	2 NO	1
HNYU02	9-65 A Auxiliary Contact Block	2 NC	1
HNYU11	9-65 A Auxiliary Contact Block	1 NO + 1 NC	1
HNYYB11	17-65 A Auxiliary Contact Block	1 NO + 1 NC	5

Contactor Coil

Code	Features	Box/Pcs
IH13*	HN09-HN13	1
IH25*	HN17-HN40	1

* For Voltage selection, please use below codes.



IH13U

Code	Voltage
B	440V / 50 HZ
C	366V / 50 HZ
D	110-115V / 50-60 HZ
F	24V / 50-60 HZ
G	48V / 50HZ
U	220-230V / 50-60 HZ
W	380-400V / 50-60 HZ
X	220-240V / 50 HZ
Z	480-500V / 50 HZ

Thermal Relay



JA25A

Code	Current Calibration Interval (A)	Box/Pcs
JA25A	0.15 - 0.25	1
JA25B	0.22 - 0.33	1
JA25C	0.30 - 0.45	1
JA25D	0.42 - 0.63	1
JA25E	0.60 - 0.90	1
JA25F	0.85 - 1.27	1
JA25G	1.20 - 1.75	1
JA25H	1.70 - 2.60	1
JA25I	2.50 - 3.70	1
JA25L	3.60 - 5.40	1
JA25M	5.30 - 7.50	1
JA25N	7.30 - 10.2	1
JA25O	10.0 - 15.0	1
JA25P	13.5 - 20.0	1
JA25Q	18.0 - 26.0	1

Direct Starters with Contactor and Thermal Relay



HJ12X09UB

HJ12- HJ22 with Box

Code	Type	Current Calibration Interval (A)	Contactor Rated Current (A) 380V	Power (kW) 380 - 415V	Box Size
HJ12X09UA	Box with Start and Reset Buttons	0.15 - 0.25	9	0,06	2. Boy
HJ12X09UB*	Box with Start and Reset Buttons	0.22 - 0.33	9	0,09	2. Boy
HJ12X09UC*	Box with Start and Reset Buttons	0.30 - 0.45	9	0,12	2. Boy
HJ12X09UD*	Box with Start and Reset Buttons	0.42 - 0.63	9	0,15	2. Boy
HJ12X09UE*	Box with Start and Reset Buttons	0.60 - 0.90	9	0,24	2. Boy
HJ12X09UF*	Box with Start and Reset Buttons	0.85 - 1.27	9	0,37	2. Boy
HJ12X09UG*	Box with Start and Reset Buttons	1.20 - 1.75	9	0,55	2. Boy
HJ12X09UH*	Box with Start and Reset Buttons	1.70 - 2.60	9	1,1	2. Boy
HJ12X09UI*	Box with Start and Reset Buttons	2.50 - 3.70	9	1,5	2. Boy
HJ12X09UL*	Box with Start and Reset Buttons	3.60 - 5.40	9	2,2	2. Boy
HJ12X09UM*	Box with Start and Reset Buttons	5.30 - 7.50	9	3	2. Boy
HJ12X13UN*	Box with Start and Reset Buttons	7.30 - 10.2	13	4	2. Boy
HJ22X17UO*	Box with Start and Reset Buttons	10.0 - 15.0	17	5,5	4. Boy
HJ22X25UP*	Box with Start and Reset Buttons	13.5 - 20.0	25	7,5	4. Boy
HJ22X25UQ*	Box with Start and Reset Buttons	18.0 - 26.0	25	11	4. Boy

* If you require Signal included in the box, you can put "S" to end of the code. In that case, S100NK's Signal price will be added.

HJ11- HJ 21 with Box



HJ11A09UG

Code	Type	Current Calibration Interval (A)	Contactor Rated Current (A) 380V	Power (kW) 380 - 415V	Box Size
HJ11A09UG	with illuminated on-off switch + with reset button + with 10 mm Signal lamp	1.20 - 1.75	9	0.55	1. Size
HJ11A09UH		1.70 - 2.60	9	1.10	1. Size
HJ11A09UI		2.50 - 3.70	9	1.50	1. Size
HJ11A09UL		3.60 - 5.40	9	2.20	1. Size
HJ11A09UM		5.30 - 7.50	9	3.00	1. Size
HJ11A13UN		7.30 - 10.2	13	4.00	1. Size
HJ21A17UO		10.0 - 15.0	17	5,50	3. Size
HJ21A25UP		13.5 - 20.0	25	7,50	3. Size
HJ21A25UQ		18.0 - 26.0	25	11.00	3. Size

Empty Box

Code	Type	Box/Pcs
HJ11	1. Size	1
HJ12	2. Size	1
HJ21	3. Size	1
HJ22	4. Size	1

RE1P08DC024



RS1P08G1

Industrial Relays & Sockets



RE1P08DC024

Industrial Relays

Code	Number of Pins	Coil Voltage	Number of Contacts	Box/Pcs
RE1P08AC012	8 pins	12V AC	2 Changeover Contacts	25
RE1P08AC024	8 pins	24V AC	2 Changeover Contacts	25
RE1P08AC048	8 pins	48V AC	2 Changeover Contacts	25
RE1P08AC110	8 pins	110V AC	2 Changeover Contacts	25
RE1P08AC220	8 pins	230V AC	2 Changeover Contacts	25
RE1P08DC012	8 pins	12V DC	2 Changeover Contacts	25
RE1P08DC024	8 pins	24V DC	2 Changeover Contacts	25
RE1P08DC048	8 pins	48V DC	2 Changeover Contacts	25
RE1P08DC110	8 pins	110V DC	2 Changeover Contacts	25
RE1P11AC012	11 pins	12V AC	3 Changeover Contacts	25
RE1P11AC024	11 pins	24V AC	3 Changeover Contacts	25
RE1P11AC048	11 pins	48V AC	3 Changeover Contacts	25
RE1P11AC110	11 pins	110V AC	3 Changeover Contacts	25
RE1P11AC220	11 pins	230V AC	3 Changeover Contacts	25
RE1P11DC012	11 pins	12V DC	3 Changeover Contacts	25
RE1P11DC024	11 pins	24V DC	3 Changeover Contacts	25
RE1P11DC048	11 pins	48V DC	3 Changeover Contacts	25
RE1P11DC110	11 pins	110V DC	3 Changeover Contacts	25



RS1P08G1

Relay Sockets

Code	Number of Pins	Colour*	Box/Pcs
RS1P08*1	8 pins	M H G	10
RS1P11*1	11 pins	M H G	10

*Colour; M: Blue, H: Black, G: Grey



SSS4X



SSRR1EA012

RZ4D1S208K



RZ4A3M708P



RZ1A1A12S-25



RR3MP1N



RR3VP02



SSRP1DB012



RZ3A1A30S2

Electronic Products

Solid State Relays



SSRP1DB040



SSRP1DA025



SSRR1EA012

Code	Control Voltage	Mounting	Phase	Load Voltage Range	Max Load Current	Box/Pcs
SSRP1DA012	4 - 32 VDC	Base Mount	1 Phase	24-320V AC	12A	1
SSRP1DA025	4 - 32 VDC	Base Mount	1 Phase	24-320V AC	25A	1
SSRP1DA040	4 - 32 VDC	Base Mount	1 Phase	24-320V AC	40A	1
SSRP1DB012	4 - 32 VDC	Base Mount	1 Phase	50-480V AC	12A	1
SSRP1DB025	4 - 32 VDC	Base Mount	1 Phase	50-480V AC	25A	1
SSRP1DB040	4 - 32 VDC	Base Mount	1 Phase	50-480V AC	40A	1
SSRP1DC050	4 - 32 VDC	Base Mount	1 Phase	50-640V AC	50A	1
SSRP1DC070	4 - 32 VDC	Base Mount	1 Phase	50-640V AC	70A	1
SSRP1DC100	4 - 32 VDC	Base Mount	1 Phase	50-640V AC	100A	1
SSRP1DC120	4 - 32 VDC	Base Mount	1 Phase	50-640V AC	120A	1
SSRR1EA012	8-30V AC/DC	Rail Type	1 Phase	24-320V AC	12A	1
SSRR1EA025	8-30V AC/DC	Rail Type	1 Phase	24-320V AC	25A	1
SSRR1EB012	8-30V AC/DC	Rail Type	1 Phase	50-480V AC	12A	1
SSRR1EB025	8-30V AC/DC	Rail Type	1 Phase	50-480V AC	25A	1



SSS1X



SSS4X



SSS5F

SSS Series Solid State Heat Sinks

Code	Installation	Dimension	Suitable Solid State (Base Mounting)	Feature	Box/Pcs
SSS1X	Rail Type	45 x 75 mm	12A	W/O Fan	1
SSS2X	Rail Type	45 x 100 mm	25A	W/O Fan	1
SSS2F	Rail Type	45 x 100 mm	40A	With Fan	1
SSS4X	Rail Type	100 x 75 mm	40A	W/O Fan	1
SSS4F	Rail Type	100 x 75 mm	50A	With Fan	1
SSS5X	Rail Type	100 x 100 mm	50A	W/O Fan	1
SSS5F	Rail Type	100 x 100 mm	70A, 100A, 120A	With Fan	1

Rail Type Electronic Relays

Time Relays



RR3ZTS30



RR3VP01



RR3LL01



RR3LLPROP



RR3FR01

Code	Operating Voltage	Time Range	Function				Control Output	Box/Pcs
			F1	F2	F3	F4		
RR3ZTC01	24V DC/VAC-220V AC	0,06 sec. - 30 hour	√	√	√	√	1 Changeover Relay 10A/250V AC	10
RR3ZTC02*		0,6 sec. - 10 hour			√*	√*	1 Changeover Relay 10A/250V AC	10
RR3ZTS30		0,1-30 sec.adj	√				1 Changeover Relay 10A/250V AC	10
RR3ZTS60		0,1-60 sec.adj	√				1 Changeover Relay 10A/250V AC	10

F1.Delay ON Function / F2. Delay OFF Function / F3. ON Flasher Function / F4. OFF Flasher Function / F5. Bypass

*In this model on-off times are separately adjustable.

Voltage Protection

Code	Operating Voltage	Time Delay Adjustment	Over Voltage Protection Level	Under Voltage Protection Level	Phase Sequence & Phase Loss Protection	Control Output	Box/Pcs
RR3VP01	220 VAC	0,1 - 20 sec. Adjustable	230-300 VAC	150-210 VAC	Single Phase	1 Changeover Relay 10A/250VAC	10
RR3VP02			Adjustable	Adjustable	Three Phase	1 Changeover Relay 10A/250V AC	10
RR3VP02N	380 VAC	0,1 - 10 sec. Adjustable	%5-%30 Adjustable	%5-%30 Adjustable	Three Phase (without Neutral)	1 Changeover Relay 10A/250V AC	10

Liquid Level Control

Code	Operating Voltage	Electrode	Adjustment Sensitivity(kΩ)	Dimensions	Control Output	Box/Pcs
RR3LL01	220 VAC	base,bottom,top	2 - 50		1 Changeover Relay 10A/250VAC	10
RR3LLPROP		Electrode		Size 90mm dia 19mm		10

Photocell Relay

Code	Operating Voltage	Lux Scale	Time elay	Control	Protection	Control Output	Box/Pcs
RR3FR01	220 VAC	1-10 LUX	25s-40s	Automatic	-	1 changeover Relay 10A/250V AC	10
RR3FRG0Z				LDR Light Sensor			10



RR3MP1N



RR3MP4FP

Motor Protection

Code	Operating Voltage	Voltage Asymmetry	Phase Loss	Phase Sequence	Thermal Protection	Control Output	Box/Pcs
RR3MP1N	220V AC	%20	✓			1 Changeover Relay 10A/250VAC	10
RR3MP2N		%40	✓			1 Changeover Relay 10A/250VAC	10
RR3MP2F		%40	✓	✓		1 Changeover Relay 10A/250VAC	10
RR3MP2FP		%40	✓	✓		1 Changeover Relay 10A/250VAC	10
RR3MP4F		%5-15	✓	✓		1 Changeover Relay 10A/250VAC	10
RR3MP4FP		%5-15	✓	✓		1 Changeover Relay 10A/250VAC	10
RR3MP4FPN		%5-15	✓	✓ Without Neutral		1 Changeover Relay 10A/250VAC	10
RR3MP5FN		%15	✓	✓ Without Neutral		1 Changeover Relay 10A/250VAC	10

Star Delta Relay

Code	Operating Voltage	Time Range	Function	Control Output	Box/Pcs
RR3YU01	220V AC	Star:3-30s, Star->Delta:50-500m	Star Delta	2NO relay 10A/250VAC	10
RR3YU02		Star:3-30s,Star-Delta:50-500ms,Right-Left:0.6s-5min	Star Delta& Right Left Relay	2NO relay 10A/250VAC	10

Ø22 mm Electronic Time Relays

Analogue Time Relays

Code	Function	Time Range	Operating Voltage	Number of Contacts	Box/Pcs
RZ3A1A30M2	Delay On	0,5-30 min.	10-30V DC	PNP Transistor Output	1
RZ3A1A60M2	Delay On	1-60 min.	10-30V DC	PNP Transistor Output	1
RZ3A1A30S2	Delay On	0,1-30 sec.	10-30V DC	PNP Transistor Output	1
RZ3A1A60S2	Delay On	0,1-60 sec.	10-30V DC	PNP Transistor Output	1



RZ3A1A30S2



RZ3A1A60S2

36x36 mm Electronic Relays

Analogue Time Relays

With Single Relay

Code	Function	Time Range	Operating Voltage	Number of Contacts	Box/Pcs
RZ1A1A03*-1	Delay On	0.3 - 3 sec/m	12V AC/DC	1 Changeover Contact	1
RZ1A1A03*-25	Delay On	0.3 - 3 sec/m	24V AC/DC - 220V AC	1 Changeover Contact	1
RZ1A1A06*-1	Delay On	0.6 - 6 sec/m	12V AC/DC	1 Changeover Contact	1
RZ1A1A06*-25	Delay On	0.6 - 6 sec/m	24V AC/DC - 220V AC	1 Changeover Contact	1
RZ1A1A12*-1	Delay On	1.2 - 12 sec/m	12V AC/DC	1 Changeover Contact	1
RZ1A1A12*-25	Delay On	1.2 - 12 sec/m	24V AC/DC - 220V AC	1 Changeover Contact	1
RZ1A1A30*-1	Delay On	3 - 30 sec/m	12V AC/DC	1 Changeover Contact	1
RZ1A1A30*-25	Delay On	3 - 30 sec/m	24V AC/DC - 220V AC	1 Changeover Contact	1
RZ1A1A60S-1	Delay On	6 - 60 sec/m	12V AC/DC	1 Changeover Contact	1
RZ1A1A60S-25	Delay On	6 - 60 sec/m	24V AC/DC - 220V AC	1 Changeover Contact	1
RZ1A1B03*-1	Delay Off	0.3 - 3 sec/m	12V AC/DC	1 Changeover Contact	1
RZ1A1B03*-25	Delay Off	0.3 - 3 sec/m	24V AC/DC - 220V AC	1 Changeover Contact	1
RZ1A1B06*-1	Delay Off	0.6 - 6 sec/m	12V AC/DC	1 Changeover Contact	1
RZ1A1B06*-25	Delay Off	0.6 - 6 sec/m	24V AC/DC - 220V AC	1 Changeover Contact	1
RZ1A1B12*-1	Delay Off	1.2 - 12 sec/m	12V AC/DC	1 Changeover Contact	1
RZ1A1B12*-25	Delay Off	1.2 - 12 sec/m	24V AC/DC - 220V AC	1 Changeover Contact	1
RZ1A1B30*-1	Delay Off	3 - 30 sec/m	12V AC/DC	1 Changeover Contact	1
RZ1A1B30*-25	Delay Off	3 - 30 sec/m	24V AC/DC - 220V AC	1 Changeover Contact	1
RZ1A1B60S-1	Delay Off	6 - 60 sec/m	12V AC/DC	1 Changeover Contact	1
RZ1A1B60S-25	Delay Off	6 - 60 sec/m	24V AC/DC - 220V AC	1 Changeover Contact	1



RZ1A1A12S-25



RZ1A2C06S-2

With Double Relay

Code	Function	Time Range	Operating Voltage	Number of Contacts	Box/Pcs
RZ1A2C03*-1	Delay On & Delay Off	0.3 - 3 sec/m	12V AC/DC	1 Changeover Contact + 1Normally Open Contact	1
RZ1A2C03*-2	Delay On & Delay Off	0.3 - 3 sec/m	24V AC/DC	1 Changeover Contact + 1Normally Open Contact	1
RZ1A2C03*-5	Delay On & Delay Off	0.3 - 3 sec/m	220V AC	1 Changeover Contact + 1Normally Open Contact	1
RZ1A2C06*-1	Delay On & Delay Off	0.6 - 6 sec/m	12V AC/DC	1 Changeover Contact + 1Normally Open Contact	1
RZ1A2C06*-2	Delay On & Delay Off	0.6 - 6 sec/m	24V AC/DC	1 Changeover Contact + 1Normally Open Contact	1
RZ1A2C06*-5	Delay On & Delay Off	0.6 - 6 sec/m	220V AC	1 Changeover Contact + 1Normally Open Contact	1
RZ1A2C12*-1	Delay On & Delay Off	1.2 -12 sec/m	12V AC/DC	1 Changeover Contact + 1Normally Open Contact	1
RZ1A2C12*-2	Delay On & Delay Off	1.2 -12 sec/m	24V AC/DC	1 Changeover Contact + 1Normally Open Contact	1
RZ1A2C12*-5	Delay On & Delay Off	1.2 -12 sec/m	220V AC	1 Changeover Contact + 1Normally Open Contact	1
RZ1A2C30*-1	Delay On & Delay Off	3 - 30 sec/m	12V AC/DC	1 Changeover Contact + 1Normally Open Contact	1
RZ1A2C30*-2	Delay On & Delay Off	3 - 30 sec/m	24V AC/DC	1 Changeover Contact + 1Normally Open Contact	1
RZ1A2C30*-5	Delay On & Delay Off	3 - 30 sec/m	220V AC	1 Changeover Contact + 1NormallyOpen Contact	1
RZ1A2C60S-1	Delay On & Delay Off	6 - 60 sec/m	12V AC/DC	1 Changeover Contact + 1Normally Open Contact	1
RZ1A2C60S-2	Delay On & Delay Off	6 - 60 sec/m	24V AC/DC	1 Changeover Contact + 1Normally Open Contact	1
RZ1A2C60S-5	Delay On & Delay Off	6 - 60 sec/m	220V AC	1 Changeover Contact + 1Normally Open Contact	1

*Time Mode: S: second (sec) ; M: minute (m)

Note 1: 48x48 adaptor will be supplied free of charge whenever needed.

Note 2: All electronic relays must be used together with RS1P08 Sockets



RZ1D1B-1

Digital Time Relay

Code	Operating Voltage	Number of Contacts	Time Range	Function*										Box/Pcs		
				A	B	F1	F2	S1	S2	S3	S4	I	P		R	
RZ1D1S-1	12V AC/DC	1 Changeover Contact	0.1-99.59sn.	√	√	√	√	√	√	√	√	√	√	√	√	1
RZ1D1S-2	24V AC/DC	1 Changeover Contact	0.1-99.59sn.	√	√	√	√	√	√	√	√	√	√	√	√	1
RZ1D1S-4	110V AC	1 Changeover Contact	0.1-99.59sn.	√	√	√	√	√	√	√	√	√	√	√	√	1
RZ1D1S-5	220V AC	1 Changeover Contact	0.1-99.59sn.	√	√	√	√	√	√	√	√	√	√	√	√	1
RZ1D1B-1	12V AC/DC	1 Changeover Contact	0.1-99.59sn.	√	√	√	√	√	√	√	√	√	√	√	√	1
RZ1D1B-2	24V AC/DC	1 Changeover Contact	0.1-99.59sn.	√	√	√	√	√	√	√	√	√	√	√	√	1
RZ1D1B-5	220V AC	1 Changeover Contact	0.1-99.59sn.	√	√	√	√	√	√	√	√	√	√	√	√	1
RZ1D1R-1	12V AC/DC	1 Changeover Contact	0.1-99.59sn.	√	√	√	√	√	√	√	√	√	√	√	√	1
RZ1D1R-2	24V AC/DC	1 Changeover Contact	0.1-99.59sn.	√	√	√	√	√	√	√	√	√	√	√	√	1
RZ1D1R-5	220V AC	1 Changeover Contact	0.1-99.59sn.	√	√	√	√	√	√	√	√	√	√	√	√	1



RZ1D1C-5

Digital Counters

Code	Operating Voltage	Number of Contacts	Counter Entry	Reset Entry	Box/Pcs
RZ1D1C-2	24V AC/DC	1 Changeover Contact	12-30V DC Pals	12-30V DC Pals	1
RZ1D1C-5	220V AC	1 Changeover Contact	12-30V DC Pals	12-30V DC Pals	1



RDA1A

Digital Panelmeters

Code	Type	Operating Voltage	Number of Contacts	Counter Entry	Box/Pcs
RDA1A	Ampermeter	220/230V AC	1 Changeover Contact	0-5 A	1
RDV1A	Voltmeter	220/230V AC	1 Changeover Contact	0-600V AC	1
RDH1A	Frequency meter	220/230V AC	1 Changeover Contact	100-250V AC / 30-70 Hz	1



RAM1S

Motor Protection Relay

Code	Operating Voltage	Number of Contacts	Protection Phase Sequence	Protection Phase Loss	Box/Pcs
RAM1S	3x380V AC	1 Changeover Contact	√	√	1

48x48 mm Electronic Relays



RZ4A3M708P

Analogue Time Relays

Code	Operating Voltage	Number of Contacts	Time Range	Function*										Box/ Pcs				
				A	B	F1	F2	S1	S2	S3	S4	I	P		R			
RZ4A3M708P	24-240V AC/DC	2 ChangeoverContact	0.05 sec-100 hour	√	√	√	√											1
RZ4A3M708K	24-240V AC/DC	2 ChangeoverContact	0.05 sec-100 hour	√	√	√	√											1

Digital Time Relays

Code	Operating Voltage	Number of Contacts	Time Range	Function*										Box/ Pcs					
				A	B	F1	F2	S1	S2	S3	S4	I	P		R				
RZ4D1S108P	12V AC/DC	1 Changeover Contact	0.1 sec-99 h.59 min	√	√	√	√	√	√	√	√	√	√	√	√	√	√	√	1
RZ4D1S208P	24V AC/DC	1 Changeover Contact	0.1 sec-99 h.59 min	√	√	√	√	√	√	√	√	√	√	√	√	√	√	√	1
RZ4D1S408P	110V AC	1 Changeover Contact	0.1 sec-99 h.59 min	√	√	√	√	√	√	√	√	√	√	√	√	√	√	√	1
RZ4D1S508P	230V AC	1 Changeover Contact	0.1 sec-99 h.59 min	√	√	√	√	√	√	√	√	√	√	√	√	√	√	√	1
RZ4D1S108K	12V AC/DC	1 Changeover Contact	0.1 sec-99 h.59 min	√	√	√	√	√	√	√	√	√	√	√	√	√	√	√	1
RZ4D1S208K	24V AC/DC	1 Changeover Contact	0.1 sec-99 h.59 min	√	√	√	√	√	√	√	√	√	√	√	√	√	√	√	1
RZ4D1S408K	110V AC	1 Changeover Contact	0.1 sec-99 h.59 min	√	√	√	√	√	√	√	√	√	√	√	√	√	√	√	1
RZ4D1S508K	230V AC	1 Changeover Contact	0.1 sec-99 h.59 min	√	√	√	√	√	√	√	√	√	√	√	√	√	√	√	1
RZ4D1B108P	12V AC/DC	1 Changeover Contact	0.1 sec-99 h.59 min	√	√	√	√	√	√	√	√	√	√	√	√	√	√	√	1
RZ4D1B208P	24V AC/DC	1 Changeover Contact	0.1 sec-99 h.59 min	√	√	√	√	√	√	√	√	√	√	√	√	√	√	√	1
RZ4D1B508P	230V AC	1 Changeover Contact	0.1 sec-99 h.59 min	√	√	√	√	√	√	√	√	√	√	√	√	√	√	√	1
RZ4D1B108K	12V AC/DC	1 Changeover Contact	0.1 sec-99 h.59 min	√	√	√	√	√	√	√	√	√	√	√	√	√	√	√	1
RZ4D1B208K	24V AC/DC	1 Changeover Contact	0.1 sec-99 h.59 min	√	√	√	√	√	√	√	√	√	√	√	√	√	√	√	1
RZ4D1B508K	230V AC	1 Changeover Contact	0.1 sec-99 h.59 min	√	√	√	√	√	√	√	√	√	√	√	√	√	√	√	1
RZ4D1R108P	12V AC/DC	1 Changeover Contact	0.1 sec-99 h.59 min	√	√	√	√	√	√	√	√	√	√	√	√	√	√	√	1
RZ4D1R208P	24V AC/DC	1 Changeover Contact	0.1 sec-99 h.59 min	√	√	√	√	√	√	√	√	√	√	√	√	√	√	√	1
RZ4D1R508P	230V AC	1 Changeover Contact	0.1 sec-99 h.59 min	√	√	√	√	√	√	√	√	√	√	√	√	√	√	√	1
RZ4D1R108K	12V AC/DC	1 Changeover Contact	0.1 sec-99 h.59 min	√	√	√	√	√	√	√	√	√	√	√	√	√	√	√	1
RZ4D1R208K	24V AC/DC	1 Changeover Contact	0.1 sec-99 h.59 min	√	√	√	√	√	√	√	√	√	√	√	√	√	√	√	1
RZ4D1R508K	230V AC	1 Changeover Contact	0.1 sec-99 h.59 min	√	√	√	√	√	√	√	√	√	√	√	√	√	√	√	1



RZ4D1S208K

Digital Counters

Code	Operating Voltage	Number of Contacts	Counter Entry	Reset Entry	Box/ Pcs
RZ4D1C208P	24V AC/DC	1 ChangeoverContact	12-30V Dc Pals	12-30V DcPals	1
RZ4D1C508P	230VAC	1 ChangeoverContact	12-30V Dc Pals	12-30V DcPals	1
RZ4D1C208K	24V AC/DC	1 ChangeoverContact	12-30V Dc Pals	12-30V DcPals	1
RZ4D1C508K	230VAC	1 ChangeoverContact	12-30V Dc Pals	12-30V DcPals	1



RZ4D1S208P

*Functions

- A: Delay On
- B: Delay Off
- F1: Flasher with delay on energy
- F2: Flasher with delay off energy
- S1: Timing on energy with start input
- S2: Delay on energy with start input
- S3: Timing on energy with start input break
- S4: Delay on energy with start input (2)
- I: Waiting (Inhibit)
- P: Start possibility from front panel
- R: Reserve



L51K23LUM324

Safety Products



CP200EP



CP200EA30

Emergency Stop Button

CP/CM Series Emergency Stop

Code	Type	Contact Block	Dia (mm)	Colour	Box/Pcs
CP200E30		1 NC	30	●	10
CP200ES30	With Signal	1 NC	30	●	10
CP200EA30	Key Operated	1 NC	30	●	10
CP200ECN30	Pull to Release	1 NC	30	●	10
CP200ECS30	With Signal, Pull to Release	1 NC	30	●	10
CP200E	Turn to Release	1 NC	40	●	10
CP200EE	Turn to Release, With Label	1 NC	40	●	10
CP200EK30	Turn to Release	1 NC	30	●	10
CP200EP	With Window	1 NC	40	●	10
CM200E	Mushroom	1 NC	40	●	10
CM200EE	Turn to release with Label	1 NC	40	●	10



B200E30



B200EE

B Series Emergency Stop

Code	Type	Contact Block	Dia (mm)	Colour	Box/Pcs
B200E30		1 NC	30	●	10
B102E30		1 NO + 1 NC	30	●	10
B200E		1 NC	40	●	10
B200EE	With Plate	1 NC	40	●	10
B102E		1 NO + 1 NC	40	●	10
B200E60		1 NC	60	●	5
B102E60		1 NO + 1 NC	60	●	5
B200EG		1NC	40	●	10



KB12E

KB Series Emergency Stop

Code	Contact Block	Colour	Box/Pcs
KB12E	1 NC	●	10
KB14E	1 NO + 1 NC	●	10



H200EE

H Series Emergency Stop (30 mm)

Code	Type	Contact Block	Dia (mm)	Colour	Box/Pcs
H200EE	Turn to release with label	1 NK	40	●	10



PK1SE

Emergency Stop Control Box

PK Series

Code	Button Qty	Features	Box Colour	Box/Pcs
PK1SE	Single	With Emergency Stop Button	Yellow-Black	1



P1EC400E40K



P1C400E72

P Series (Plastic Enclosed)

Code	Button Qty	Features	Box Colour	Box/Pcs
P1EC400E40	Single	Emergency Stop	Yellow-Black	1
P1EC400E40K	Single	Emergency Stop, With Plate	Yellow-Black	1
P1C400E72	Single	72mm. Emergency Stop	Grey-Black	1
PA1E40LED1	Single	Emergency Stop, With LED Label	Yellow-Black	1



M1C200E40

M Series (Metal Enclosed)

Code	Button Qty	Features	Box Colour	Box/Pcs
M1C200E40	Single	Emergency Stop	Yellow-Grey	1
M1C200EE	Single	Emergency Stop, With Label	Yellow-Grey	1

Limit Switches



L5K23LEM411



L5K23BEM621



L5K23LUM324



L5K23LUM323

L5 Series, Plastic Body Slow Action

Code	Actuator	Actuator Type	End Unit Material	Box/Pcs
L5K23LEM411*	Hinge	Plastic	Metal	1
L5K23LEM412*	Hinge	Plastic	Metal	1
L5K23LEM511*	Hinge	Plastic	Metal	1
L5K23LEM621*	Hinge	Plastic	Metal	1
L5K23LEM622*	Hinge	Plastic	Metal	1
L5K23BEM621*	Rotational Tube	Plastic	Metal	1
L5K23LUM320*	Straight and Curved Key	Plastic	Metal	1
L5K23LUM321*	Curved Key	Plastic	Metal	1
L5K23LUM322*	Straight Key	Plastic	Metal	1
L5K23LUM323*	Movable Key	Plastic	Metal	1
L5K23LUM324*	Movable Key	Plastic	Metal	1
L5K23CPDE*	Emergency Stop	Plastic	Plastic	1



L51K23LUM321



L51K23HUM112

L51 Series, Metal Body, Slow Action

Code	Actuator	Actuator Type	End Unit Material	Box/Pcs
L51K23LUM320*	Straight and Curved Key	Metal	Metal	1
L51K23LUM321*	Curved Key	Metal	Metal	1
L51K23LUM322*	Straight Key	Metal	Metal	1
L51K23LUM323*	Movable Key	Metal	Metal	1
L51K23LUM324*	Movable Key	Metal	Metal	1
L51K23HUM111*	Metal Ring	Metal	Metal	1
L51K23HUM112*	Metal Ring, with Reset	Metal	Metal	1

Maximum usable wire length is 12 metre for L51K23HUM111 and L51K23HUM112 limit switches



L52K23HUM111



L52K23HUM112

L52 Series, Metal Body, Slow Action

Code	Actuator	Actuator Type	End Unit Material	Box/Pcs
L52K23LUM320*	Straight and Curved Key	Metal	Metal	1
L52K23LUM321*	Curved Key	Metal	Metal	1
L52K23LUM322*	Straight Key	Metal	Metal	1
L52K23LUM323*	Movable Key	Metal	Metal	1
L52K23LUM324*	Movable Key	Metal	Metal	1
L52K23HUM111*	Metal Ring	Metal	Metal	1
L52K23HUM112*	Metal Ring, with Reset	Metal	Metal	1

* Positive Opening Function

Maximum usable wire length can is 12 metre for L52K23HUM111 and L52K23HUM112 limit switches



CEKPB



CEKPAB

Two Hand Control Panel

Code	Description	Colour	Base
CEKP1	2 Sides, 1 Middle Hole		
CEKP3	2 Sides, 3 Middle Hole		
CEKP3G	2 Sides, 3 Middle Hole, Grey		
CEKP5	2 Sides, 5 Middle Hole		
CEKPA	2 Sides, 1 Middle Hole		✓
CEKPB	1 pcs CM200E (middle), 2 pcs CM200MY (2 sides)		
CEKPAB	1 pcs CM200E (middle), 2 pcs CM200MY (2 sides)		✓

Code	Accessories
CEKA	Base For Two Hand Panel



VT2050



VT Kaplin



VTKAMD



VTKAMA



PV3E30B2



CSM10

Crane Products

Crane Control Boxes



PVK2E



PVK4E

PVK Series IP 65

Code	Button Qty	Box Colour	Box/Pcs
PVK2E	2	Single Speed	1
PVK2X	2	Blank	1
PVK3E	3	Single Speed	1
PVK3X	2	Blank	1
PVK4E	4	Single Speed	1
PVK4X	4	Blank	1
PVK5E	5	Single Speed	1
PVK6E	6	Single Speed	1
PVK6X	6	Blank	1
PVK7E	7	Single Speed	1
PVK8E	8	Single Speed	1



PV3E30B4



PV5T144



PV7E30B444



PV9E30B4444



PV3E30B3



PV9E30B222AA20

PV Series IP 65

Code	Hole Qty	1.Hole	Contact	Speed	Box/Pcs
PV2Z2	2	1.Hole Closed		Single Speed	1
PV2Z4	2	1.Hole Closed		Single-Double Speed	1
PV2ZX	2	1.Hole Closed		Blank	1
PV3AC20A2	3	Key Selector	1NO	Single Speed	1
PV3AC20B2	3	Key Selector	1NC	Single Speed	1
PV3E30B2	3	Emergency Stop	1NC	Single Speed	1
PV3E30B3	3	Emergency Stop	1NC	Single Speed	1
PV3E30B4	3	Emergency Stop	1NC	Double Speed	1
PV3E30E2	3	Emergency Stop	2NC	Single Speed	1
PV3E30E4	3	Emergency Stop	2NC	Double Speed	1
PV3T12	3	Blind Cap		Single Speed	1
PV3T14	3	Blind Cap		Double Speed	1
PV3T1X	3	Blind Cap		Blank	1
PV3X	3			Blank	1
PV4Z22	4	1.Hole Closed		Single Speed	1
PV4Z42	4	1.Hole Closed		Double-Single Speed	1
PV4Z44	4	1.Hole Closed		Double Speed	1
PV4ZX	4	1.Hole Closed		Blank	1
PV5AA20C24	5	Key Selector	1NC+1NO	Single Speed	1
PV5AC20A22	5	Key Selector	1NO	Single Speed	1
PV5AC20B22	5	Key Selector	1NC	Single Speed	1
PV5E30B22	5	Emergency Stop	1NC	Single Speed	1
PV5E30B2AC20	5	Key Selector	1NC	Single Speed	1
PV5E30B33	5	Emergency Stop	1NC	Single Speed (2NO)	1
PV5E30B42	5	Emergency Stop	1NC	Double-Single Speed	1
PV5E30B44	5	Emergency Stop	1NC	Double Speed	1
PV5E30B4A20	5	Key Selector	1NC	Double Speed	1
PV5E30E22	5	Emergency Stop	2NC	Single Speed	1
PV5E30E44	5	Emergency Stop	2NC	Double Speed	1
PV5E40B22	5	Emergency Stop	1NC	Single Speed	1
PV5E40C22	5	Emergency Stop	1NC+1NO	Single Speed	1
PV5T122	4	Blind Cap		Single Speed	1
PV5T142	5	Blind Cap		Single-Double Speed	1
PV5T144	5	Blind Cap		Double Speed	1
PV5X	5			Blank	1
PV6Z222	6	1.Hole Closed		Single Speed	1
PV6Z444	6	1.Hole Closed		Double Speed	1
PV6ZX	6	1.Hole Closed		Blank	1
PV7AA20C222	7	Key Selector	1NC+1NO	Single Speed	1
PV7AC20A222	7	Key Selector	1NO	Single Speed	1
PV7AC20A444	7	Key Selector	1NO	Double Speed	1
PV7AC20B222	7	Key Selector	1NC	Single Speed	1
PV7AC20B444	7	Key Selector	1NC	Double Speed	1

PV Series IP 65

Code	Hole Qty	1.Hole	Contact	Speed	Box/Pcs
PV7E30B222	7	Emergency Stop	1NC	Single Speed	1
PV7E30E222	7	Emergency Stop	1NC+1NC	Single Speed	1
PV7E30B22AC20	7	Key Selector	1NC	Single Speed	1
PV7E30B333	7	Emergency Stop	1NC	Single Speed (2NO)	1
PV7E30B422	7	Emergency Stop	1NC	Single Speed	1
PV7E30B444	7	Emergency Stop	1NC	Double Speed	1
PV7E30B44AC20	7	Key Selector	1NC	Double Speed	1
PV7E30C422	7	Emergency Stop	1NC+1NO	Single Speed	1
PV7E40B222	7	Emergency Stop	1NC	Single Speed	1
PV7E40B22AC20	7	Key Selector	1NC	Single Speed	1
PV7E40B444	7	Emergency Stop	1NC	Double Speed	1
PV7EA30B222	7	Emergency Stop	1NC	Single Speed	1
PV7EA30B444	7	Emergency Stop	1NC	Double Speed	1
PV7T1222	7	Blind Cap		Single Speed	1
PV7T1444	6			Double Speed	1
PV7T1X	7	Blind Cap		Blank	1
PV7X	7			Blank	1
PV8E30B444S30	8	Selector	1NC	Double Speed	1
PV8Z2222	8	1.Hole Closed		Single Speed	1
PV8Z4444	8	1.Hole Closed		Double Speed	1
PV8ZX	8	1.Hole Closed		Blank	1
PV9AC20C4444	9	Key Selector	1NC+1NO	Double Speed	1
PV9AC30B4444	9	Key Selector	1NC	Double Speed	1
PV9E30B2222	9	Emergency Stop	1NC	Single Speed	1
PV9E30B222AA20	8	Key Selector	1NC	Single Speed	1
PV9E30B222AC20	9	Key Selector	1NC	Single Speed	1
PV9E30B4444	9	Emergency Stop	1NC	Double Speed	1
PV9E30B444AA20	9	Key Selector	1NC	Double Speed	1
PV9E30B444AC20	9	Key Selector	1NC	Double Speed	1
PV9E30E2222	9	Emergency Stop	2NC	Single Speed	1
PV9E30E4444	9	Emergency Stop	2NC	Double Speed	1
PV9E40B222AC20	9	Key Selector	1NC	Single Speed	1
PV9E40B4444	9	Emergency Stop	1NC	Double Speed	1
PV9E40B444AC20	9	Key Selector	1NC	Double Speed	1
PV9EA30B2222	9	Emergency Stop	1NC	Single Speed	1
PV9EA30B4444	9	Emergency Stop	1NC	Double Speed	1
PV9T12222	9	Blind Cap		Single Speed	1
PV9T14444	9	Blind Cap		Double Speed	1
PV9T1X	9	Blind Cap		Blank	1
PV9X	9			Blank	1



PVCHBD - PVCHSD - PVTHBD - PVTHSD

PV Series Spare Parts

Code	Type	Speed	Colour	Box/Pcs
PVB1	Start Contact Block	-	●	20
PVB2	Stop Contact Block	-	●	20
PVCHBD	Button	Double Speed	○	20
PVCHSD	Button	Double Speed	●	20
PVTHBD	Button	Single Speed	○	20
PVTHSD	Button	Single Speed	●	20
PVA	Adapter			
CP200EK30	Turn to Release-Short Emergency Stop 1 NC (40 mm)		●	10



CSM10



CSM02

Cross Limit Switch, Metal Body, IP 65

Code	Type	Features	Actuator Length	Box/Pcs
CSM02	180°	1 forward step, 1 reverse step	200 mm	1
CSM023	180°	1 forward step, 1 reverse step	300 mm	1
CSM04	360°	2 forward steps, 2 reverse steps	200 mm	1
CSM043	360°	2 forward steps, 2 reverse steps	300 mm	1
CSM10	360°	Eternal	200 mm	1
CSM103	360°	Eternal	300 mm	1

CSM02

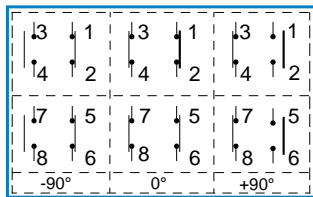

CSM04

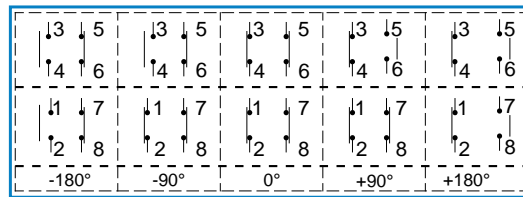

CSM10

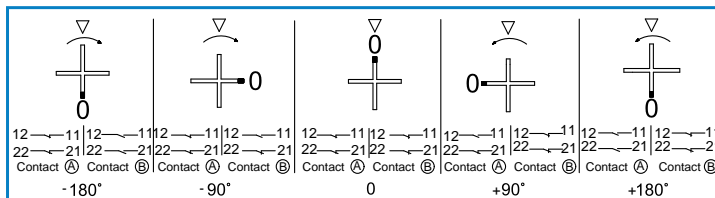

Rotational Limit Switch, IP67



VT2050



VT4300

Code	Switch Quantity	Cam Degree	Contact	Box/Pcs
VT2***	2	20°	2*CO	1
VT3***	3	20°	3*CO	1
VT4***	4	20°	4*CO	1
VT2***D	2	60°	2*CO	1
VT3***D	3	60°	3*CO	1
VT4***D	4	60°	4*CO	1

Note: Ratios are 1/25, 1/50, 1/75, 1/100, 1/150, 1/200, 1/300

For ratios, please fill 3 digit number instead of ***

i.e.: VT2050 means 2 switch qty and 050 ratios

Accessories for Rotational Limit Switch



VTKAMA

VTKAMD

Code	Cam Degree
VTKAMA	20°
VTKAMD	60°
VTKAPLİN	

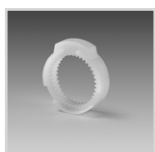



Z73



PSA010ZL123C



Z7401



L5K23MUM332R



PA4443



PY4ASB2

Lift Products



PARK4SB



PA3311



PA4411



PA6601



PA4412



PA1E40K



PA4401



PA1BOS



PA8801

Lift Push Button Stations

Code	Number of Holes	Features	Box Colour	Box/Pcs
PA1101	1	MBZS024S	Yellow-Black	1
PA1111	1	B100AA21	Yellow-Black	1
PA1171	1	MBZS024S	Yellow-Black	1
PA1172	1	MBZS012S	Yellow-Black	1
PA1191	1	BPR10K	Yellow-Black	1
PA1BOS	1	Empty	Yellow-Black	1
PA1E40K	1	CP200E+BET60	Yellow-Black	1
PA2202	2	CP200EP + EPREU1H	Yellow-Grey	1
PA2211	2	B100DHL+B200EE	Yellow-Black	1
PA2221	2	MBSD012Y + MBSD012K	Grey-Grey	1
PA2222	2	MBSD024Y + MBSD024K	Grey-Grey	1
PA2225	2	MBSD220Y + MBSD220K	Grey-Grey	1
PA2AB	2	B102K20KY + MBZS024S	Yellow-Grey	1
PA2BOS	2	Empty	Yellow-Black	1
PA2BOSP	2	Empty (1 x 22 mm + 1 x Panel Socket Hole)	Yellow-Grey	1
PA2E40P1	1	B200E + EPREU1M	Yellow-Black	1
PA3304	3	B100DHL + CP200EP + EPREU1H	Yellow-Grey	1
PA3311	3	B102K20HSZL + B200E + EPREU1M+BMUHAFAZA	Yellow-Black	1
PA3312	3	B102K20KY + B200E + EPREU1M	Yellow-Grey	1
PA3313	3	CP102K20YY + CP200E + EPREU1M	Yellow-Grey	1
PA3BOS	3	Empty	Yellow-Black	1
PA3E40P1	3	B200E + EPREU1M + Stopper	Yellow-Grey	1
PA4401	4	CP200E + CP100DM + CP102K20HBOK + PSA020KD340AR	Yellow-Black	1
PA4402	4	B200E + BMUHAFAZA + B101DMOO + B606K20HBOK + PSA020KD340AR	Yellow-Black	1
PA4403	4	CP200E + CP100DM + CP102K20HBOK + PSA020ZS332AR	Yellow-Black	1
PA4404	4	B200E + B101DMOO + B606K20HBOK + PSA020ZS332AR (Cable gland)	Yellow-Black	1
PA4405	4	CP200E + CP100DM + CP101K20HBOK + PSA020ZT332AR	Yellow-Black	1
PA4406	4	CP200EP + CP101DB + CP101DB + PSA020ZS332AR	Yellow-Black	1
PA4407	4	CP200E + CP100DM + CP101K20HB + PSA020ZT332AR	Yellow-Black	1
PA4408	4	CP200EP + CP100DM + CP102K20HB + PSA020ZT332AR	Yellow-Black	1
PA4409	4	CP200EP + CP100DM/MOK + CP808K20HBOK + PSA020ZA332AR	Yellow-Black	1
PA4411	4	CP200E + CP100DY + CP101S20 + EPREU1M	Yellow-Black	1
PA4412	4	B200E + B100DHL + B100DSZ + EPREU1M	Yellow-Black	1
PA4443	4	CP200EP + CP101K20SMZO + CP808K20HBOK + PSA020ZS332AR	Yellow-Black	1
PA4444	4	CP102E + CP808K20HBOK + CP102K20SMZO + PSA020ZS332AR	Yellow-Black	1
PA4445	4	CP200EP + CMUHAFAZA + CP101DBOY + CP101DHOY + PSA020ZA332AR	Yellow-Black	1
PA4446	4	CP200EP + CMUHAFAZA + CP808K20HBOK + CP101K20SMZO + PSA020ZA332AR	Yellow-Black	1
PA4BOS	4	Empty	Yellow-Black	1
PA5501	5	CP200E + CP101DHOY + CP100DB + CMUHAFAZA + MBSD024Y + EPREU1M + PSA020KD340AR	Yellow-Black	1
PA5502	5	CP200EE + CP100DH + CP100DM + PSA020ZT332AR	Yellow-Black	1
PA5503	5	CP200E + CP100Y + CP100DY + EPREU1M + PSA020KD340AR	Yellow-Black	1
PA5BOS	5	Empty	Yellow-Black	1
PA6601	6	CP200E + CMUHAFAZA + CP101K20HBOK + CP100DM + CP101S30 + CP101S30 + PSA020KD340AR	Yellow-Black	1
PA6602	6	CP200E + CP102K20HB + CP100DM + CP101S30 + PSA020KD340AR	Yellow-Black	1
PA6603	6	CP200EP + CMUHAFAZA + CP601DH + CP100DS + CP100DM + CP601DB + PSA020ZA332AR	Yellow-Black	1
PA6BOS	6	Empty	Yellow-Black	1
PA8801	8	CP200E + CP101DB + CP101DH + CP101K20HSZL + CP100DM + CP101S30 + CP101S30 + PSA020KD340AR	Yellow-Black	1
PA8811	8	B101DB + B100DHL + B100DH + B100DM + B100DSZ + EPREU1M + PSA020ZA431AR	Yellow-Black	1
PA8BOS	8	Empty	Yellow-Black	1
PA9971	9	MB100DH + MB100DY + MB100DM + MB102DH + MB102DH + MB101S20 + MB200EE + EPREU1M + EPRUS1H	Yellow-Black	1
PA9972	9	MB100DH + MB100DY + MB100DM + MB102DH + MB102DH + MB200S20 + MB200EE + EPREU1M + EPRUS1H	Yellow-Black	1
PA9BOS	9	Empty	Yellow-Black	1
PA9E40P2	9	B102DH + B102DH + B100DH + B100DM + B100DY + B200EE + B102S20 + EPREU1M + EPRUS1H	Yellow-Black	1
PARK4B	3	B102DBOD + B102DBOD + B200EE	Yellow-Black	1
PARK4B	4	B100DB + B100DB + B200EE	Yellow-Black	1
PARK4BDM	4	B100DBOD + B100DMOD + B100DMOD + B200EE	Yellow-Black	1
PARK4BOS	4	Empty	Yellow-Black	1
PARK4CS1	4	CP100DBOD + CP200EP + CP100DHOD + CP100DM	Yellow-Black	1
PARK4M1	4	CP102DBOD + CP200E + CP102DHOD + S100LK1	Yellow-Black	1
PARK4M2	4	CP101DBOD + CP200E + CP101DHOD	Yellow-Black	1
PARK4SB	4	B102DBOD + B102DBOD + B200EE + B101S20	Yellow-Black	1
PARK4SIB	4	B102DBOD + B102DBOD + B200EE + S100K	Yellow-Black	1

Note: Control Boxes have IP65 protection degree, but the minimum IP of the button is accepted for the complete product.

Accessories

Code	Features	Material
PA4AA	Lift Station box with 4 bracket apparatus	Plastic
PA8AA	Lift Station box with 8 bracket apparatus	Plastic



Z70



Z71



Z73



Z7401



L5K23MUM332R



L5K13MEL123A

Lift Products

Code	Type	Box/Pcs
Z70	Plug	16
Z71	Socket-Single Entry	16
Z72	Socket-Double Entry	16
Z73	Plug	16
Z7401	Mounting Screw M4*11,5 mm	16
Z7402	Mounting Screw M4*6,5 mm	16
Z7403	Mounting Screw M4*20 mm	16

Limit Switches

Code	Actuator	Actuator Type	End Unit Material
L5K13MEL123*	Angular Action Roller Two Way	Plastic	Rubber
L5K13MEL123A*	Angular Action Roller Two Way	Plastic	Rubber
L5K13MEL123R	Angular Action Roller Two Way, Adjustable,with Reset	Plastic	Rubber
L5K23MUM331R*	Linear Roller, with Reset	Plastic	Metal
L5K23MUM332R*	Linear Roller, with Reset	Plastic	Metal
L51K13MEL123*	Angular Action Roller Two Way	Metal	Rubber
L51K13MEL123A*	Angular Action Roller Two Way	Metal	Rubber
L51K23MUM331R*	Linear Roller, with Reset	Metal	Metal
L51K23MUM332R*	Linear Roller, with Reset	Metal	Metal

* Positive Opening Features

ByPass Cam Switches



PSA010ZL123C



PSA010ZL123C

Code	Rated Thermal Current (A)	Instruction	Place of Usage	Scheme
PSA010ZL123S	10A	48*48 mm Framed + Standard Handle	-	
PSA010ZL123C	10A	w/o Frame + PSMK Mounted	-	
PSA010ZL123AR	10A	w/o Frame + with Handle suitable for Enclosure	-	
PSA010ZR221S	10A	48*48 mm Framed + Standard Handle	-	
PSA010ZR221AR	10A	w/o Frame + with Handle suitable for Enclosure	-	
PSA020KD340AR	20A	w/o Frame + with Handle suitable for Enclosure	PA4401, PA4402, PA5501, PA6601, PA8801	
PSA020ZA431AR	20A	w/o Frame + with Handle suitable for Enclosure	PA8811	
PSA020ZT332AR	20A	w/o Frame + with Handle suitable for Enclosure	PA4405	
PSA020ZS332AR	20A	w/o Frame + with Handle suitable for Enclosure	PA4403, PA4404, PA4443	

Accessories



PSMK



PSMK

Code	Type	Feature	Material
PSMK	between 10-25A	Handle Cover	Plastic



HKP020025R3A

HKP015015R1A

HKP040060R8A

HKP020025ZKA

HKP040060ZSA

HKP020025ZEA

Cable Carriers



HKP015015R1A



HKP020025R3A



HKP040060R5A



HKP015015ZDA



HKP015015ZEA

Code	Material	Inner Height	Inner Width	Bending Radius	Type	Box/Pcs
HKP015015R1A	Plastic	15 mm	15 mm	25 mm	Open	1 x 1 m
HKP020025R3A	Plastic	20 mm	25 mm	40 mm	Open	1 x 1 m
HKP040060R5A	Plastic	40 mm	60 mm	100 mm	Open	1 x 1 m

Code	Material	Inner Height	Inner Width	Features	Box/Pcs
HKP015015ZDA	Plastic	15 mm	15 mm	Internal Connection	10
HKP015015ZEA	Plastic	15 mm	15 mm	External Connection	10
HKP015015ZKA	Plastic	15 mm	15 mm	Upper	100
HKP020025ZDA	Plastic	20 mm	25 mm	Internal Connection	10
HKP020025ZEA	Plastic	20 mm	25 mm	External Connection	10
HKP020025ZKA	Plastic	20 mm	25 mm	Upper	100
HKP040060ZDA	Plastic	40 mm	60 mm	Internal Connection	1
HKP040060ZEA	Plastic	40 mm	60 mm	External Connection	1
HKP040060ZKA	Plastic	40 mm	60 mm	Upper	20
HKP040060Z5A	Plastic	40 mm	-	Seperator	20



HKP015015ZKA



HKP020025ZDA



HKP020025ZEA



HKP020025ZKA



HKP040060Z5A

BENDING RADIUS

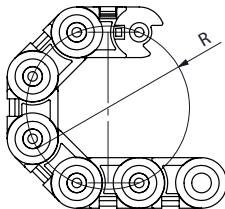

R1	25 mm	R6	125 mm
R2	35 mm	R7	150 mm
R3	40 mm	R8	200 mm
R4	75 mm	R9	250 mm
R5	100 mm		

B Series Control Units Selection Table

Series	Contact Block Combination			Button Type	Colour	Pad Printing
B	1	K	2	D	K	1
B B Series Ø 22 mm Control Units	Contact Block Type 1 Start - For Button 2 Stop - For Button	Contact Block Type 0 Empty 1 Start - For Button 2 Stop - For Button		Spring Type D Flush F Stay Put H Extended M Mushroom Ø 40 mm Key Operated Type AA20 2 Position, Stay Put (0-1) ↕ AA21 2 Position, Spring Return (0-1) ↕ AA30 3 Position, Stay Put (II-0-I) ↕ AA31 3 Position, Single Spring Return (II-0-I) ↕ AA32 3 Position, Double Spring Return (II-0-I) ↕ AC20 2 Position, Stay Put (II-0-I) ↕ AC30 3 Position, Stay Put (II-0-I) ↕ ⚠ Taking key out position Selector Type S20 2 Position, Stay Put (0-1), 60° ↙ S21 2 Position, Spring Return (0-1), 60° ↗ S30 3 Position, Stay Put (II-0-I), 60° ↘ S31 3 Position, Single Spring Return (II-0-I), 60° ↘ S32 3 Position, Double Spring Return (II-0-I), 60° ↘ SL20 2 Position, Illuminated Stay Put (0-1) ↙ SL21 2 Position, Illuminated Spring Return (0-1) ↗ SL30 3 Position, Illuminated Stay Pu (II-0-I) ↘ SL31 3 Position, Illuminated Single Spring Return (II-0-I) ↘ SL32 3 Position, Illuminated Double Spring Return (II-0-I) ↘ T20 2 Position, Stay Put (0-1), 90° ↘ T21 2 Position, Spring Return (0-1), 90° ↘ R20 2 Position, Stay Put (0-1), 45° ↙ R21 2 Position, Spring Return (0-1), 45° ↗ C Handle Switch Emergency Stop Type E30 Ø 30 mm, Turn to Release E Ø 40 mm, Turn to Release EE Ø 40 mm, With Label, Turn to Release E60 Ø 60 mm, Turn to Release EG Ø 40 mm With Position Curser Turn to Release Double Type K20 Flush K21 Flush, Single Extender K22 Flush, Double Extender B20 Big Double Flush B30 Triple Signle Extended Stop X Pilots	Colour B White K Red M Blue S Yellow Y Green H Black Mat	0 0 Printed 10 I-0 Printed 1 I Printed 2 II Printed 12 I-II Printed L LIGHT Printed OD OK Vertical Printed OY OK Horizontal Printed OK OK Special Printed OO OK Special Printed S Siren Sign Z Bell Sign
	Illumination Block Type O Empty B 100-230 V AC/DC With White LED K 100-230 V AC/DC With Red LED M 100-230 V AC/DC With Blue LED S 100-230 V AC/DC With Yellow LED Y 100-230 V AC/DC With Green LED 5 12-30 V AC/DC With White LED 6 12-30 V AC/DC With Red LED 7 12-30 V AC/DC With Blue LED 8 12-30 V AC/DC With Yellow LED 9 12-30 V AC/DC With Green LED Q 48 V AC/DC With White LED X 48 V AC/DC With Red LED V 48 V AC/DC With Blue LED W 48 V AC/DC With Yellow LED Z 48 V AC/DC With Green LED C 110 V AC/DC With White LED D 110 V AC/DC With Red LED E 110 V AC/DC With Blue LED F 110 V AC/DC With Yellow LED G 110 V AC/DC With Green LED 3* Illumination Block Suitable for Ba9S Bulbs					

*Only for B Series

Example: B1K2DK → B series, start, stop, 100 - 230V AC, With Red LED, red flush type control unit has been selected.

C Series Control Units Selection Table

Series	Contact Block Combination	Button Type	Colour	Pad Printing
CM	1 K 2	D	K	1

CP	CP Series Plastic Ø 22 mm Control Units
CM	CM Series Metal Ø 22 mm Control Units

Spring Type	Colour
D Flush	B White
F Stay Put	K Red
M Mushroom Ø 40 mm	M Blue
H Extended	S Yellow
	Y Green
	H Black Mat

Key Operated Type Buttons
AA20 2 Position, Stay Put (0-I) ↕
AA21 2 Position, Spring Return (0-I) ↕
AA30 3 Position, Stay Put (II-0-I) ↕
AA31 3 Position, Single Spring Return (II-0-I) ↕
AA32 3 Position, Double Spring Return (II-0-I) ↕
AC20 2 Position, Stay Put (II-0-I) ↕
AC30 3 Position, Stay Put (II-0-I) ↕
Ω Taking key out position

Selector Type
S20 2 Position, Stay Put (0-I), 60° ↕
S21 2 Position, Spring Return (0-I), 60° ↕
S30 3 Position, Stay Put (II-0-I), 60° ↕
S31 3 Position, Single Spring Return (II-0-I), 60° ↕
S32 3 Position, Double Spring Return (II-0-I), 60° ↕

Joystick
DJ20 2 Position, Stay Put
DJ21 2 Position, Spring Return
DJ40 4 Position, Stay Put
DJ41 4 Position, Spring Return

Emergency Stop Type (Only CP Plastic Series)
E30 Ø 30 mm, Turn to Release*
EK30 Ø 30 mm, Short, Turn to Release*
EA30 Ø 30 mm, Key Operated, Turn to Release*
ES30 Ø 30 mm, With Signal, Turn to Release*
ECN30 Ø 30 mm, Pull to Release*
ECS30 Ø 30 mm, With Signal, Pull to Release*
E Ø 40 mm, Turn to Release
EC Ø 40 mm, Pull to Release
EE Ø 40 mm, Turn to Release, With Label
EP Ø 40 mm, With Window, Pull to Release
* Snap Locked

Double Head Buttons
K20 Flush
K21 Single Extended
X Pilots

0	1	2	3	4	5	6	7	8	9
Empty	Start For Button	Stop For Button	Tandem Start - Start	Tandem Start - Stop	Tandem Stop - Stop	Start - Start Vertical	Start - Stop Vertical	Stop - Stop Vertical	Start - Stop in Single Contact

Illumination Block Type
0 Empty
B 100-230 V AC/DC With White LED
K 100-230 V AC/DC With Red LED
M 100-230 V AC/DC With Blue LED
S 100-230 V AC/DC With Yellow LED
Y 100-230 V AC/DC With Green LED
5 12-30 V AC/DC With White LED
6 12-30 V AC/DC With Red LED
7 12-30 V AC/DC With Blue LED
8 12-30 V AC/DC With Yellow LED
9 12-30 V AC/DC With Green LED
Q 48 V AC/DC With White LED
X 48 V AC/DC With Red LED
V 48 V AC/DC With Blue LED
W 48 V AC/DC With Yellow LED
Z 48 V AC/DC With Green LED
C 110 V AC/DC With White LED
D 110 V AC/DC With Red LED
E 110 V AC/DC With Blue LED
F 110 V AC/DC With Yellow LED
G 110 V AC/DC With Green LED
N 220V DC With White LED
O 220V DC With Red LED
P 220V DC With Blue LED
R 220V DC With Yellow LED
T 220V DC With Green LED

0	10	1	2	12	L	OD	OY	OK	OO	S	Z
0	I-0	I	II	I-II	LIGHT	OK	OK	OK	OK	Siren Sign	Bell Sign
Printed	Printed	Printed	Printed	Printed	Printed	Vertical Printed	Horizontal Printed	Special Printed	Special Printed		

Example: CM1K2DK → C Series, Metal, start, stop, 100 - 230V AC, with red LED, red flush type control unit has been selected.

D Series Control Units Selection Table

Series	Contact Block Combination			Button Shape	Button Type	Colour
D	1	6	2	D	D	K
Series D D Series Ø 16 mm Control Units	Contact Block Type 0 Empty 1 Start For Button 2 Stop For Button			Button Shape 0 Empty 1 Start For Button 2 Stop For Button	Button Type Spring Type D Flush M30 Mushroom Ø 30 mm Selector Type S20 2 Position Stay Put (0-I) 60° S21 2 Position Spring Return (0-I) 60° S30 3 Position Stay Put (II-0-I) 60° S31 3 Position Single Spring Return (II-0-I) 60° S32 3 Position Double Spring Return (II-0-I) 60° Emergency Stop Type E30 Ø 30mm Turn to Release Pilots X Pilots	
Illumination Block Type 0 Empty 5 12 - 24V AC/DC With White LED 6 12 - 24V AC/DC With Red LED 7 12 - 24V AC/DC With Blue LED 8 12 - 24V AC/DC With Yellow LED 9 12 - 24V AC/DC With Green LED			Contact Block Type D Rectangle K Square Y Round	Colour B White K Red M Blue S Yellow Y Green H Black Mat		

Example: D162DDK→D Series, start, stop, 12 - 24V AC/DC, With Red LED, Red Rectangle flush type control unit has been selected.

MB Series Monoblock Ø22 mm Control Units Selection Table

Series	Contact Combination			Button Type	Colour	Pad Printing
MB	1	0	2	D	K	1

Series

MB Series Monoblock Ø 22mm Control Units

Contact Block Type

1 Start For Button

2 Stop For Button

Contact Block Type

1 Start For Button

2 Stop For Button

Illumination Block Type

0 Empty

Button Type

Spring Type

- D** Flush
- F** Stay Put
- H** Extended
- M** Mushroom Ø 40 mm

Selector Type

S20	2 Position	Stay Put	(0-I)	60°	✓
S21	2 Position	Spring Return	(0-I)	60°	↗
S30	3 Position	Stay Put	(II-0-I)	60°	✓
S31	3 Position	Single Spring Return	(II-0-I)	60°	↗
S32	3 Position	Double Spring Return	(II-0-I)	60°	↗

Emergency Stop Type

- E** Ø 40mm Turn to Release
- EE** Ø 40mm With Label Turn to Release

Pilots

- X** Pilots

Colour

- B** White
- K** Red
- M** Blue
- S** Yellow
- Y** Green
- H** Black

Pad Printing

0	0	Printed
10	I-0	Printed
1	I	Printed
2	II	Printed
12	I-II	Printed
L	LIGHT	Printed
OD	OK	Vertical Printed
OY	OK	Horizontal Printed
OK	OK	Special Printed
OO	OK	Special Printed
S	Siren Sign	
Z	Bell Sign	

Example: MB102DK → MB Series, start, stop, Red flush type control unit has been selected.

Limit Switches Selection Table

Series	Housing Type	Contact Mode	Contact Type	End Unit Type	Action Unit	End Unit Material	Type No	Reset
L	1	K1	3	M	I	P	211	R

<p>L Limit Switches</p>	<p>1 Series</p> <p>2 Series</p> <p>3 Series</p> <p>4 Series</p> <p>5 Series</p> <p>51 Series</p> <p>52 Series</p> <p>53 Series</p> <p>54 Series</p> <p>61 Series</p> <p>66 Series</p> <p>67 Series</p>	<p>K1 Snap Action Overlap</p> <p>K2 Slow Action Overlap</p> <p>K3 Slow Action Overlap</p>	<p>1 Start-Start (NO+NO)</p> <p>2 Stop-Stop (NC+NC)</p> <p>3 Stop-Start (NC+NO)</p> <p>4 Start-Stop (NO+NC)</p> <p>5 Double Stop-Start (2NC+NO)</p> <p>6 Double Start - Double Stop 2 (NC+NO)</p> <p>7 Double Start-Stop (2NO+NC)</p> <p>8 Double Start-Double Stop 2 (NO+NC)</p> <p>9 Stop-Start Overlapped</p>	<p>M Roller</p> <p>P Plunger</p> <p>S Spiral</p> <p>F Flexible Rod</p> <p>R Rigid Rod</p> <p>L Hinge</p> <p>H Pull Wire</p> <p>B Rot Point</p> <p>CPDE Emergency</p>	<p>I Angular Action. Single Direction</p> <p>E Angular Action. Double Direction</p> <p>O Angular Action. Multiple Direction</p> <p>U Linear Action</p>	<p>P Plastic</p> <p>M Metal</p> <p>L Rubber</p> <p>F Fiber</p>	<p>111</p> <p>121</p> <p>122</p> <p>123</p> <p>124</p> <p>211</p> <p>311</p> <p>321</p> <p>323</p> <p>324</p> <p>331</p> <p>332</p> <p>411</p> <p>412</p> <p>511</p> <p>621</p> <p>622</p>	<p>Standard</p> <p>R Reset</p> <p>A Adjustable Lever</p> <p>RA Adjustable Lever With Reset</p> <p>T Opposite Mounted Lever</p> <p>Y Lever with Soft Spring</p> <p>3 3 Metre Cable</p>
--------------------------------	--	--	---	---	--	--	---	--

Standard

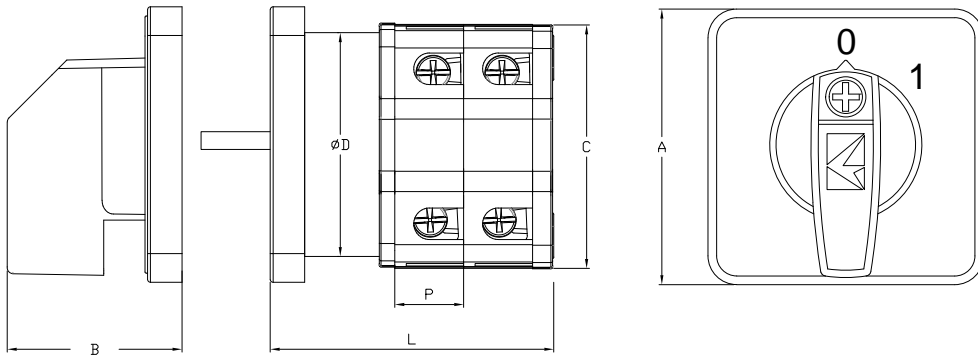

	A	B	C	D
PSA10	48	30,5	42,5	27
PSA16	48	30,5	42,5	27
PSA20	48	30,5	42,5	27
PSA25	48	30,5	42,5	27
PSA32	64	38	55	55
PSA40	64	38	55	55
PSA50	64	38	55	55
PSA63	64	38	55	55
PSA80	85	43	75	75
PSA120	95	43	85	85

Quick Installation

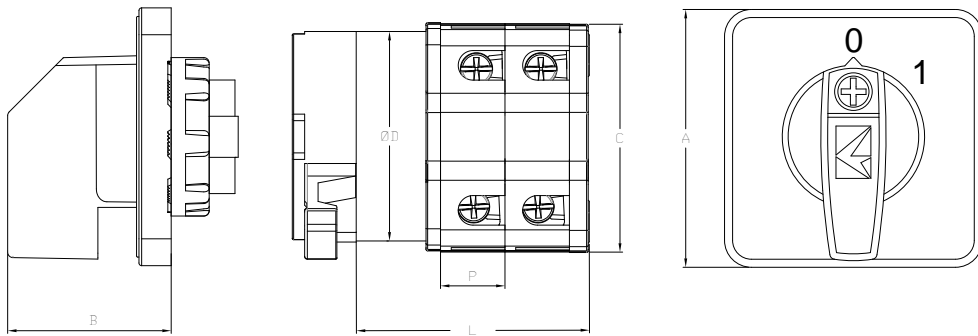

	A	B	C	D
PSA10	48	31	42,5	27
PSA16	48	31	42,5	27
PSA20	48	31	42,5	27
PSA25	48	31	42,5	27
PSA32	64	40	55	55
PSA40	64	40	55	55
PSA50	64	40	55	55
PSA63	64	40	55	55
PSA80	85	45	75	75
PSA120	95	45	85	85

Dimensions

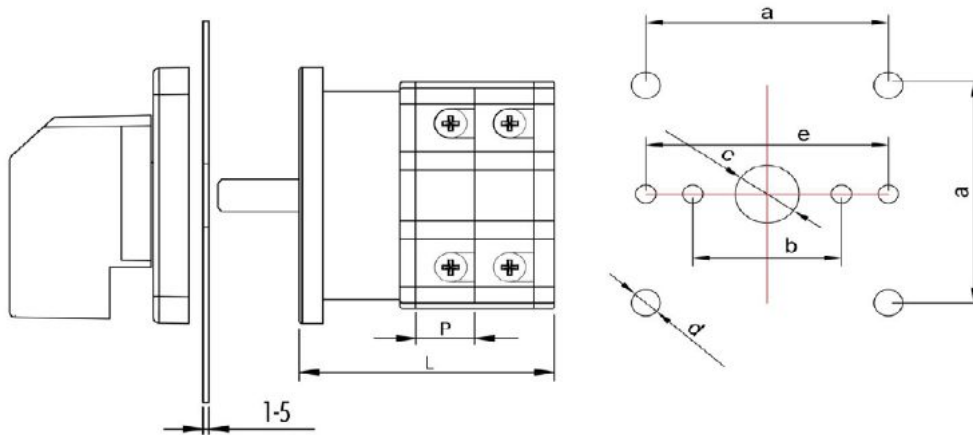

	P	L							
		1	2	3	4	5	6	7	8
PSA10	10	33,2	43,2	53,2	63,2	73,2	83,2	93,2	103,2
PSA16	10	33,2	43,2	53,2	63,2	73,2	83,2	93,2	103,2
PSA20	10	33,2	43,2	53,2	63,2	73,2	83,2	93,2	103,2
PSA25	12	35,2	47,2	59,2	71,2	83,2	95,2	107,2	119,2
PSA32	13	39,2	52,2	65,2	78,2	91,2	104,2	117,2	130,2
PSA40	15	41,2	56,2	71,2	86,2	101,2	116,2	131,2	146,2
PSA50	17,5	43,7	61,2	78,7	96,2	113,7	131,2	148,7	166,2
PSA63	21	47,2	68,2	89,2	110,2	131,2	152,2	173,2	194,2
PSA80	26	63	89	115	141	167	193	219	245
PSA120	30	63	93	123	153	183	213	243	273

	A	B	E	C	D
PSA10	36	30		9,5	4,3
PSA16	36	30		9,5	4,3
PSA20	36	30		9,5	4,3
PSA25	36	30		9,5	4,3
PSA32	48	30	50	10	4,3
PSA40	48	30	50	10	4,3
PSA50	48	30	50	10	4,3
PSA63	48	30	50	10	4,3
PSA80	68	38	50	13	5,2
PSA120	68	38	50	13	5,2

Cam Switches Selection Table

Series	Terminal Type	Amps	Type	Pole	Angle	Label	Option
PS	A	010	AK	1	3	1	S

PS Cam Switches	A Screw B Terminal C Spring Clamp	010 10 Amp 016 16 Amp 020 20 Amp 025 25 Amp 032 32 Amp 040 40 Amp 050 50 Amp 063 63 Amp 080 80 Amp 120 120 Amp 160 160 Amp 200 200 Amp	AK On-Off KD Changeover KS Step KT Multi Step MS Motor Control CD Double Speed Switch OK Measuring switch (Voltmeter-Ampermeter) Z* Special Cam Switch	For AK KT MS CD and KD Switches 1 1 Pole 2 2 Pole 3 3 Pole 4 4 Pole For KS and KT Switches 2 2 Step 3 3 Step 4 4 Step 5 5 Step 6 6 Step 7 7 Step 8 8 Step 9 9 Step For Z Switches No	1 30° Angle 2 45° Angle 3 60° Angle 4 90° Angle 5 90° Angle (Spring Return)	S 48X48 Normal E 48x48 Emergency Yellow Red B 64x64 Normal F 64x64 Emergency AQ Key Operated Quick Installation K Lockable Handle G 48x48 Emergency Grey-Black Q Quick Installation 48X48 Normal P Quick Installation 48x48 Emergency Yellow-Red	1 0 1 2 0 1 2 3 1 2 4 1 0 2 Step Switches 2 0 1 2 3 0 1 2 3 4 0 1 2 3 4 5 0 1 2 3 4 5 6 0 1 2 3 4 5 6 7 0 1 2 3 4 5 6 7 8 0 1 2 3 4 5 6 7 8 9 0 1 2 3 4 5 6 7 8 9 Motor Control Switches 4 1 0 2 5 0 Y U Measuring Cam Switches 1 0 R-N S-N T-N 2 0 R-S S-T R-T 6 0 1 2 3 4 R-T S-T R-S 0 R-N S-N T-N Special Rotary Cam Switches Special Label
------------------------	--	---	---	---	--	---	--

Example: PSA032AK131B → PSA Series, 32 A, 1 pole, 60 degrees Rotational, 0-1 on-off Cam switch has been selected.

Industrial Type Plug & Sockets Selection Table

Series	Body Material	Number Of Contacts	Type	Entry	Locking	Features
EB	M	10	FM	4	4	H
EB EB Series Industrial Type Plugs & Sockets	M Metal P Plastic O Insert	4 4 Poles (10 Amp) 5 5 Poles (10 Amp) 6 6 Poles (16 Amp) 10 10 Poles (16 Amp) 16 16 Poles (16 Amp) 24 24 Poles (16 Amp) 32 32 Poles (16 Amp) 48 48 Poles (16 Amp) 606 6 Poles (35 Amp) 612 12 Poles (35 Amp) 806 4x80 Amp, 2x16 Amp 812 8x80 Amp, 4x16 Amp	FU Hood With Male Insert FM Housing With Male Insert FD Housing With Male Insert (Surface Mounting) FE Housing with Male Insert (Sloping) PU Hood With Female Insert PM Housing With Female Insert PD Housing With Female Insert (Surface Mounting) PE Female Insert (Sloping) CF Male Insert CP Female Insert GU Hood Only GM Housing GD Housing (Surface Mounting) GE Housing (Sloping)	0 Non Entry 1 Side Entry 2 Double Side Entry 3 Top Entry 4 Bottom Entry 5 Bottom & Side Entry	0 Without 1 One Handle 2 Two Handle Roller 4 Four Handle Roller 6 Metal Opening (Single Arm) 7 Metal Handle 8 Metal Opening (Double Arm)	H Black PG21 PG21 Entry PG29 PG29 Entry

IF Series Multi Colour Beacons Selection Table

Series	Diameter	Type	Voltage	Buzzer	Connection	Cable Length
IF	5	M	024	X	M03	-1
IF Series Multi Colour Beacons	3 Ø55 mm Diameter 5 Ø55 mm Diameter 6 Ø65 mm Diameter	M Multifunction P PLC in sync R Red Y Yellow G Green W White B Blue T 3 colours N NPN PLC compatible C 3 Colours	012 012V AC/DC 030 12-30V DC 024 024V AC/DC 110 110V AC 220 220V AC	X w/o Buzzer W Buzzer with Sensitive to Sound Z With Buzzer XR w/o Buzzer Rotational ZR With Buzzer Rotational M w/o Buzzer, Mushroom O w/o Buzzer, Diamond type XF w/o Buzzer, Flash ZF With Buzzer, Flash	M01 100mm Plastic Base M02 20mm Aluminium Base M03 100mm Aluminium Base M04 500mm Aluminium Base M05 22mm Connection M06 200mm Aluminium Base S30 30mm Connection D01 Wall Base D02 Adjustable Base D40 Wall Base, Mounting with Tube, Side Entry D41 Wall Base, Mounting with Tube, Bottom Entry (Cable Gland) D50 Wall Connection with Base, Side Entry D51 Wall Connection with Base, Bottom Entry (Cable Gland)	-0.6 0.6 Metre Cable -1 1 Metre Cable -2 2 Metre Cable -3 3 Metre Cable -5 5 Metre Cable X
				W Valid Only for IF6 Series Z-XR-ZR Valid Only for IF5 Series		

IT Series Multifunctional Beacon Selection Table

Series	Diameter	Colour	Voltage	Type
IT	120	Y	024	L
IT Series Multifunctional Beacon	120 Ø120 mm Diameter	R Red Y Yellow G Green B Blue	024 024V AC/DC 48 48V AC 110 110V AC 220 220V AC	L with LED Z with LED & Buzzer

QUALITY

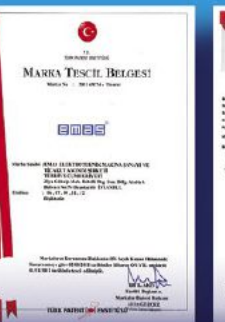





EMAS ELEKTROTEKNİK

MAKİNA SANAYİ ve TİCARET A.Ş.

İkitelli Organize Sanayi Bölgesi Mah.
Atatürk Bulvarı No: 50/A
34490 Başakşehir - İstanbul / Türkiye
Tel: +90 212 549 2252
Faks: +90 212 549 2580
444 4 969



info@emasas.com.tr
emaselectric.com

EMASAS LIMITED

G10 Schott House, Drummond Rd,
Stafford ST16 3EL
UNITED KINGDOM
(+44) 01785 747 620



info@emas.uk.com
emaselectric.co.uk