

# VENTILATION





# ROOF FANS

MODELS	UNIT	PFF4000	PFF5500	PFF6000
AIR FLOW RATE	m <sup>3</sup> /h	400	560	970
POWER SUPPLY	V/Hz	230V 50-60Hz	230V 50-60Hz	230V 50-60Hz
DIMENSIONS	mm	364x364x107	364x364x107	364x364x107
POWER CONSUMPTION	W	25/32	58/75	85/90
CURRENT CONSUMPTION	A	0.11/0,15	0.26/0.34	0.38/0.44
OVERCURRENT PROTECTION	-	THERMAL	THERMAL	THERMAL
ELECTRICAL CONNECTION	-	3-POLE TERMINAL 2.5mm <sup>2</sup>	4-POLE TERMINAL 2.5mm <sup>2</sup>	4-POLE TERMINAL 2.5mm <sup>2</sup>
OPERATING TEMPERATURE	°C	-10/+70	-10/+70	-10/+70
PROTECTION DEGREE	-	IP54	IP54	IP54
NOISE LEVEL	dB(A)	57(61)	62 (64)	72 (73)
FLOW DIRECTION	-	INSIDE / OUT	INSIDE / OUT	INSIDE / OUT
BEARING	-	BALL	BALL	BALL
SERVICE LIFE	Hour	50.000	50.000	50.000
PLASTIC MATERIAL	-	UL94 V0 ABS FLAME RETARDANT	UL94 V0 ABS FLAME RETARDANT	UL94 V0 ABS FLAME RETARDANT
GASKET	-	POLYURETHANE SEALING	POLYURETHANE SEALING	POLYURETHANE SEALING
WEIGHT	kg	2.68	3.16	3.74
MOUNTING	-	8 PCS M4 SCREWS	8 PCS M4 SCREWS	8 PCS M4 SCREWS
CONFORMITY	-	CE	CE	CE

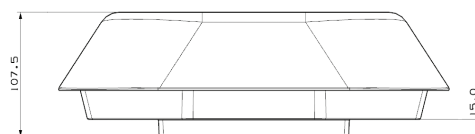
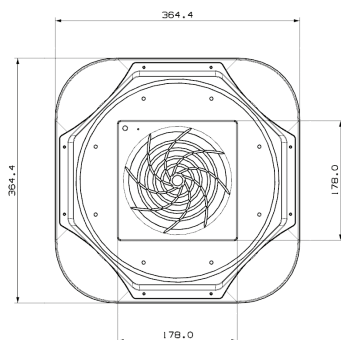



# ROOF FANS

MODELS	UNIT	PFF4000G	PFF5000G	PFF6000G
AIR FLOW RATE	m <sup>3</sup> /h	400	560	970
POWER SUPPLY	V/Hz	230V 50-60Hz	230V 50-60Hz	230V 50-60Hz
DIMENSIONS	mm	364x364x107	364x364x107	364x364x107
POWER CONSUMPTION	W	25/32	58/75	85/90
CURRENT CONSUMPTION	A	0.11/0.15	0.26/0.34	0.38/0.44
OVERCURRENT PROTECTION	-	THERMAL	THERMAL	THERMAL
ELECTRICAL CONNECTION	-	3-POLE TERMINAL 2.5mm <sup>2</sup>	4-POLE TERMINAL 2.5mm <sup>2</sup>	4-POLE TERMINAL 2.5mm <sup>2</sup>
OPERATING TEMPERATURE	°C	-10/+70	-10/+70	-10/+70
PROTECTION DEGREE	-	IP54	IP54	IP54
NOISE LEVEL	dB(A)	57(61)	62 (64)	72 (73)
FLOW DIRECTION	-	INSIDE / OUT	INSIDE / OUT	INSIDE / OUT
BEARING	-	BALL	BALL	BALL
SERVICE LIFE	Hour	50.000	50.000	50.000
PLASTIC MATERIAL	-	UL94 V0 ABS FLAME RETARDANT	UL94 V0 ABS FLAME RETARDANT	UL94 V0 ABS FLAME RETARDANT
GASKET	-	POLYURETHANE SEALING	POLYURETHANE SEALING	POLYURETHANE SEALING
WEIGHT	kg	2.68	3.16	3.74
MOUNTING	-	FAST CLIP ON	FAST CLIP ON	FAST CLIP ON
CONFORMITY	-	CE	CE	CE

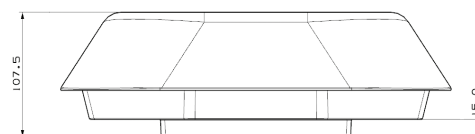
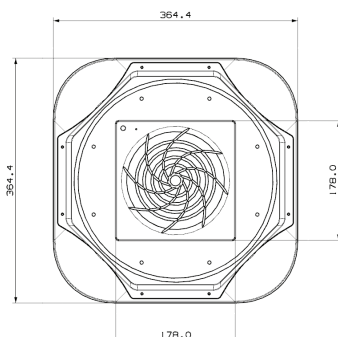



# ROOF FANS

MODELS	UNIT	PTS4000	PTS5500	PTS6000
AIR FLOW RATE	m <sup>3</sup> /h	400	560	970
POWER SUPPLY	V/Hz	230V 50-60Hz	230V 50-60Hz	230V 50-60Hz
DIMENSIONS	mm	364x364x107	364x364x107	364x364x107
POWER CONSUMPTION	W	25/32	58/75	85/90
CURRENT CONSUMPTION	A	0.11/0.15	0.26/0.34	0.38/0.44
OVERCURRENT PROTECTION	-	THERMAL	THERMAL	THERMAL
ELECTRICAL CONNECTION	-	3-POLE TERMINAL 2.5mm <sup>2</sup>	3-POLE TERMINAL 2.5mm <sup>2</sup>	3-POLE TERMINAL 2.5mm <sup>2</sup>
OPERATING TEMPERATURE	°C	-10/+70	-10/+70	-10/+70
PROTECTION DEGREE	-	IP54	IP54	IP54
NOISE LEVEL	dB(A)	62 (64)	62 (64)	72 (73)
FLOW DIRECTION	-	INSIDE / OUT	INSIDE / OUT	INSIDE / OUT
BEARING	-	BALL	BALL	BALL
SERVICE LIFE	Hour	50.000	50.000	50.000
PLASTIC MATERIAL	-	UL94 V0 ABS FLAME RETARDANT	UL94 V0 ABS FLAME RETARDANT	UL94 V0 ABS FLAME RETARDANT
GASKET	-	POLYURETHANE SEALING	POLYURETHANE SEALING	POLYURETHANE SEALING
WEIGHT	kg	2.60	3.16	3.74
MOUNTING	-	FAST CLIP ON	FAST CLIP ON	FAST CLIP ON
CONFORMITY	-	CE	CE	CE

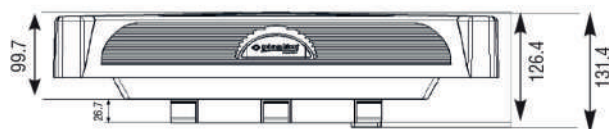
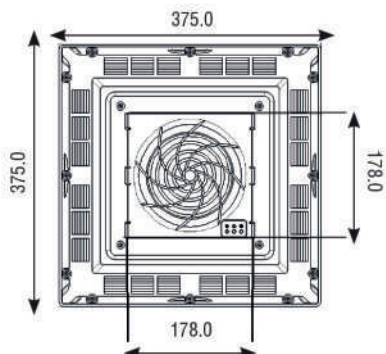



PFI1000



PTF1000



PTF1000T

**New**  
**FILTER FANS**  
**30m<sup>3</sup>/h**

MODELS	UNIT	PFI1000	PTF1000	PTF1000T
AIR FLOW RATE	m <sup>3</sup> /h	-	30 (41)	30 (41)
POWER SUPPLY	V/Hz	-	230V 50-60Hz	230V 50-60Hz
DIMENSIONS	mm	120x120x20.5	120x120x58.5	120x120x58.5
POWER CONSUMPTION	W	-	14 (13)	14 (13)
CURRENT CONSUMPTION	A	-	0.08/0.07	0.08/0.07
OVERCURRENT PROTECTION	-	-	IMPEDANCE	IMPEDANCE
ELECTRICAL CONNECTION	-	-	LEAD WIRE	3-POLE TERMINAL 2.5mm <sup>2</sup>
OPERATING TEMPERATURE	°C	-10/+70	-10/+70	-10/+70
PROTECTION DEGREE	-	IP54	IP54 / CLASS I	IP54 / CLASS I
NOISE LEVEL	dB(A)	62 (64)	28 (31)	28 (31)
FLOW DIRECTION	-	-	OUTSIDE-IN	OUTSIDE-IN
BEARING	-	-	SLEEVE	SLEEVE
PLASTIC MATERIAL	-	UL94 V0 ABS FLAME RETARDANT	UL94 V0 ABS FLAME RETARDANT	UL94 V0 ABS FLAME RETARDANT
GASKET	-	SELF-ADHESIVE	SELF-ADHESIVE	SELF-ADHESIVE
COLOR	-	RAL7035 (RAL7032 ON REQUEST)	RAL7035 (RAL7032 ON REQUEST)	RAL7035 (RAL7032 ON REQUEST)
WEIGHT	kg	0.10	0.40	0.40
MOUNTING	-	FAST CLIP ON	FAST CLIP ON	FAST CLIP ON
CONFORMITY	-	CE	CE	CE

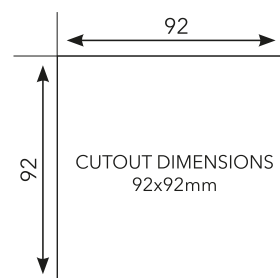
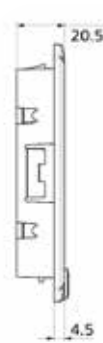
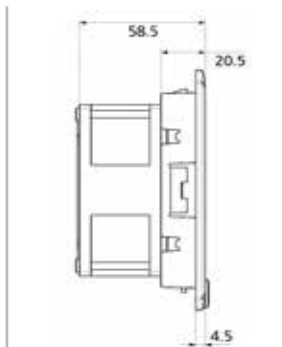
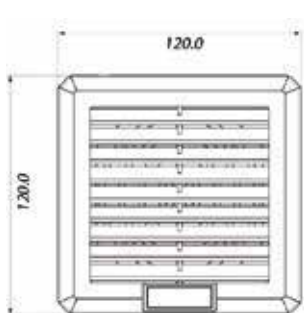



PFI1500



PTF1500



PTF1500T



# Filter Fans 100 m<sup>3</sup>/h

MODELS	UNIT	PFI1500	PTF1500	PTF1500T
AIR FLOW RATE	m <sup>3</sup> /h	-	100(140)	100(140)
POWER SUPPLY	V/Hz	-	230V 50-60Hz	230V 50-60Hz
DIMENSIONS	mm	160x160x31	160x160x69	160x160x69
POWER CONSUMPTION	W	-	26 (23)	26 (23)
CURRENT CONSUMPTION	A	-	0.14/0.13	0.14/0.13
OVERCURRENT PROTECTION	-	-	IMPEDANCE	IMPEDANCE
ELECTRICAL CONNECTION	-	-	LEAD WIRE	3-POLE TERMINAL 2.5mm <sup>2</sup>
OPERATING TEMPERATURE	°C	-10/+70	-10/+70	-10/+70
PROTECTION DEGREE	-	IP54	IP54 / CLASS I	IP54 / CLASS I
NOISE LEVEL	dB(A)	-	42 (46)	42 (46)
FLOW DIRECTION	-	-	OUTSIDE-IN	OUTSIDE-IN
BEARING	-	-	BALL	BALL
PLASTIC MATERIAL	-	UL94 V0 ABS FLAME RETARDANT	UL94 V0 ABS FLAME RETARDANT	UL94 V0 ABS FLAME RETARDANT
GASKET	-	POLYURETHANE SEALING	POLYURETHANE SEALING	POLYURETHANE SEALING
COLOR	-	RAL7035 (RAL7032 ON REQUEST)	RAL7035 (RAL7032 ON REQUEST)	RAL7035 (RAL7032 ON REQUEST)
WEIGHT	kg	0.18	0.68	0.68
MOUNTING	-	FAST CLIP ON	FAST CLIP ON	FAST CLIP ON
CONFORMITY	-	CE	CE	CE

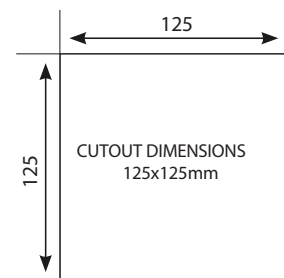
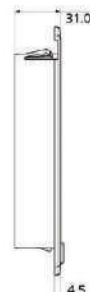
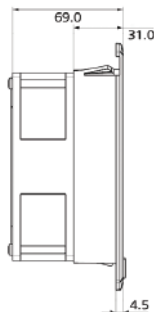
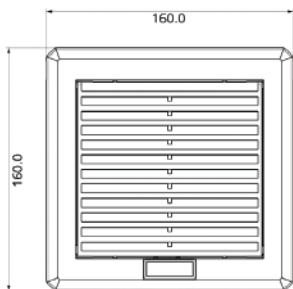



**New**  
**FILTER FANS**  
**125m<sup>3</sup>/h**

MODELS	UNIT	PFI2000	PTF2000
AIR FLOW RATE	m <sup>3</sup> /h	-	125 (175)
POWER SUPPLY	V/Hz	-	230V 50-60Hz
DIMENSIONS	mm	210x210x31	210x210x98
POWER CONSUMPTION	W	-	26 (23)
CURRENT CONSUMPTION	A	-	0.14/0.13
OVERCURRENT PROTECTION	-	-	IMPEDANCE
ELECTRICAL CONNECTION	-	-	3-POLE TERMINAL
OPERATING TEMPERATURE	°C	-10/+70	-10/+70
PROTECTION DEGREE	-	IP54	IP54 / CLASS I
NOISE LEVEL	dB(A)	-	42 (46)
FLOW DIRECTION	-	-	OUTSIDE-IN
BEARING	-	-	BALL
PLASTIC MATERIAL	-	UL94 V0 ABS FLAME RETARDANT	UL94 V0 ABS FLAME RETARDANT
GASKET	-	POLYURETHANE SEALING	POLYURETHANE SEALING
COLOUR	-	RAL7035 (RAL7032 ON REQUEST)	RAL7035 (RAL7032 ON REQUEST)
WEIGHT	kg	0.35	1.05
MOUNTING	-	FAST CLIP-ON	FAST CLIP-ON
CONFORMITY	-	CE	CE

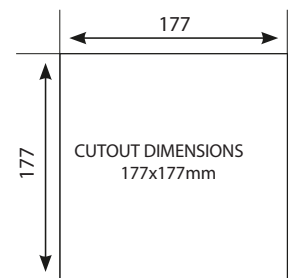
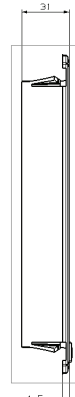
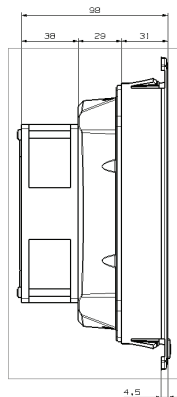
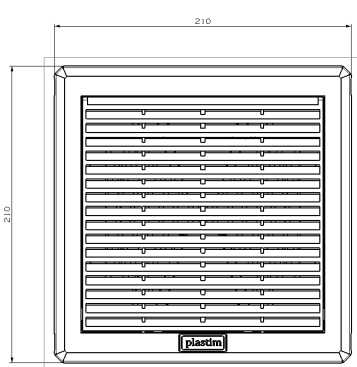



New  
**FILTER  
 FANS**  
 175m<sup>3</sup>/h

MODELS	UNIT	PFI2000	PTF3000
AIR FLOW RATE	m <sup>3</sup> /h	-	175 (245)
POWER SUPPLY	V/Hz	-	230V 50-60Hz
DIMENSIONS	mm	210x210x31	210x210x92
POWER CONSUMPTION	W	-	37 (35)
CURRENT CONSUMPTION	A	-	0.23/0.22
OVERCURRENT PROTECTION	-	-	IMPEDANCE
ELECTRICAL CONNECTION	-	-	3-POLE TERMINAL
OPERATING TEMPERATURE	°C	-10/+70	-10/+70
PROTECTION DEGREE	-	IP54	IP54 / CLASS I
NOISE LEVEL	dB(A)	-	52 (53)
FLOW DIRECTION	-	-	OUTSIDE-IN
BEARING	-	-	BALL
PLASTIC MATERIAL	-	UL94 V0 ABS FLAME RETARDANT	UL94 V0 ABS FLAME RETARDANT
GASKET	-	POLYURETHANE SEALING	POLYURETHANE SEALING
COLOUR	-	RAL7035 (RAL7032 ON REQUEST)	RAL7035 (RAL7032 ON REQUEST)
WEIGHT	kg	0.35	1.45
MOUNTING	-	FAST CLIP-ON	FAST CLIP-ON
CONFORMITY	-	CE	CE

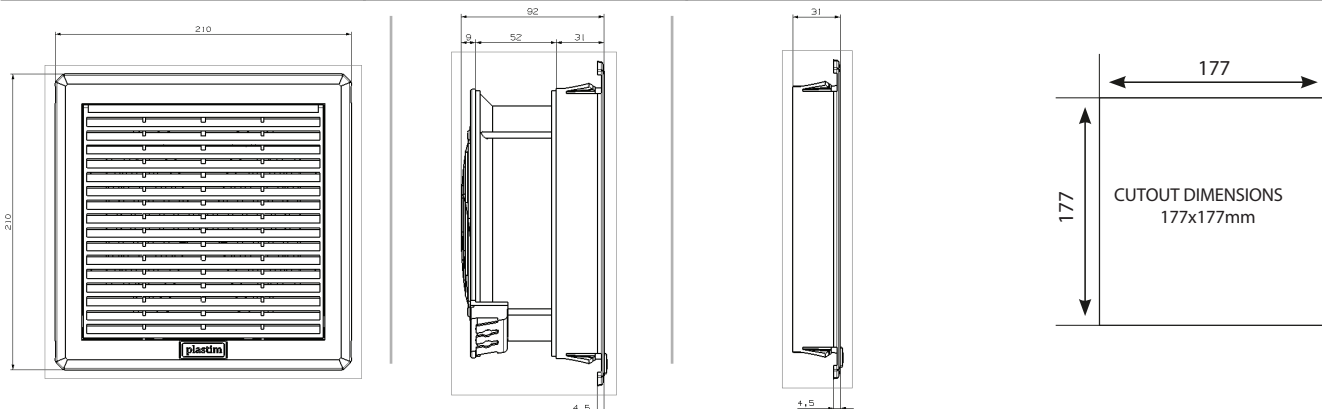





PFI2500



PTF2500



PTF2500

# FILTER FANS 115m<sup>3</sup>/h

MODELS	UNIT	PFI2500	PTF2500
AIR FLOW RATE	m <sup>3</sup> /h	-	115 (130)
POWER SUPPLY	V/Hz	-	230V 50-60Hz
DIMENSIONS	mm	260x260x31	260x260x103
POWER CONSUMPTION	W	-	26 (23)
CURRENT CONSUMPTION	A	-	0.14/0.13
OVERCURRENT PROTECTION	-	-	IMPEDANCE
ELECTRICAL CONNECTION	-	-	3-POLE TERMINAL
OPERATING TEMPERATURE	°C	-10/+70	-10/+70
PROTECTION DEGREE	-	IP54	IP54 / CLASS I
NOISE LEVEL	dB(A)	-	42 (46)
FLOW DIRECTION	-	-	OUTSIDE-IN
BEARING	-	-	BALL
PLASTIC MATERIAL	-	UL94 V0 ABS FLAME RETARDANT	UL94 V0 ABS FLAME RETARDANT
GASKET	-	POLYURETHANE SEALING	POLYURETHANE SEALING
COLOUR	-	RAL7035 (RAL7032 ON REQUEST)	RAL7035 (RAL7032 ON REQUEST)
WEIGHT	kg	0.48	1.18
MOUNTING	-	FAST CLIP-ON	FAST CLIP-ON
CONFORMITY	-	CE	CE

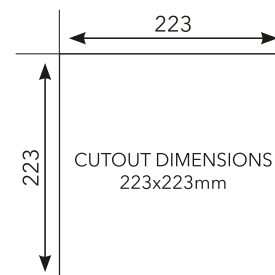
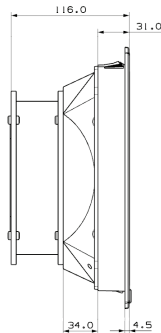
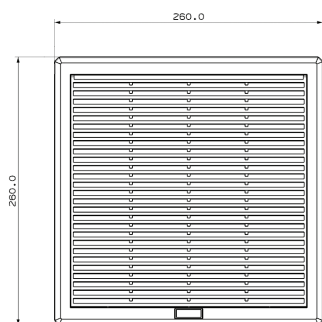



PFI2500



PTF3500



PTF3500

# FILTER FANS

## 240m<sup>3</sup>/h

MODELS	UNIT	PFI2500	PTF3500
AIR FLOW RATE	m <sup>3</sup> /h	-	240 (270)
POWER SUPPLY	V/Hz	-	230V 50-60Hz
DIMENSIONS	mm	260x260x31	260x260x103
POWER CONSUMPTION	W	-	37 (35)
CURRENT CONSUMPTION	A	-	0.23/0.22
OVERCURRENT PROTECTION	-	-	IMPEDANCE
ELECTRICAL CONNECTION	-	-	3-POLE TERMINAL
OPERATING TEMPERATURE	°C	-10/+70	-10/+70
PROTECTION DEGREE	-	IP54	IP54 / CLASS I
NOISE LEVEL	dB(A)	-	52 (53)
FLOW DIRECTION	-	-	OUTSIDE-IN
BEARING	-	-	BALL
PLASTIC MATERIAL	-	UL94 V0 ABS FLAME RETARDANT	UL94 V0 ABS FLAME RETARDANT
GASKET	-	POLYURETHANE SEALING	POLYURETHANE SEALING
COLOUR	-	RAL7035 (RAL7032 ON REQUEST)	RAL7035 (RAL7032 ON REQUEST)
WEIGHT	kg	0.48	1.60
MOUNTING	-	FAST CLIP-ON	FAST CLIP-ON
CONFORMITY	-	CE	CE

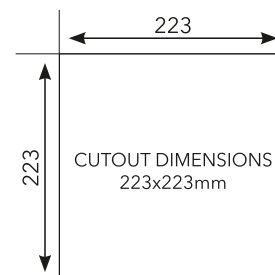
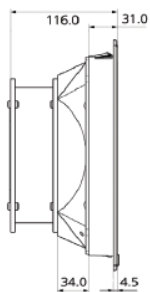
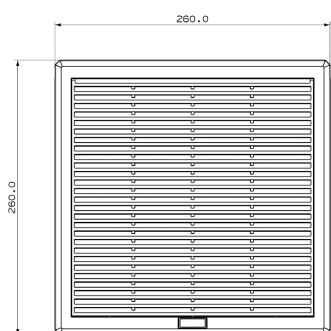



PFI2500



PTF4500



PTF4500

# FILTER FANS

650m<sup>3</sup>/h

MODELS	UNIT	PFI2500	PTF4500
AIR FLOW RATE	m <sup>3</sup> /h	-	650 (900)
POWER SUPPLY	V/Hz	-	230V 50-60Hz
DIMENSIONS	mm	260x260x31	260x260x111
POWER CONSUMPTION	W	-	66 (75)
CURRENT CONSUMPTION	A	-	0.35/0.38
OVERCURRENT PROTECTION	-	-	THERMAL
ELECTRICAL CONNECTION	-	-	4-POLE TERMINAL
OPERATING TEMPERATURE	°C	-10/+70	-10/+70
PROTECTION DEGREE	-	IP54	IP54 / CLASS I
NOISE LEVEL	dB(A)	-	60 (63)
FLOW DIRECTION	-	-	OUTSIDE-IN
BEARING	-	-	BALL
PLASTIC MATERIAL	-	UL94 V0 ABS FLAME RETARDANT	UL94 V0 ABS FLAME RETARDANT
GASKET	-	POLYURETHANE SEALING	POLYURETHANE SEALING
COLOUR	-	RAL7035 (RAL7032 ON REQUEST)	RAL7035 (RAL7032 ON REQUEST)
WEIGHT	kg	0.48	2.84
MOUNTING	-	FAST CLIP-ON	FAST CLIP-ON
CONFORMITY	-	CE	CE

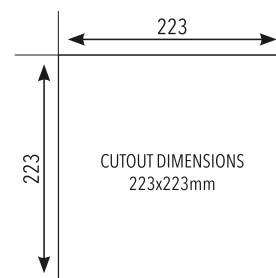
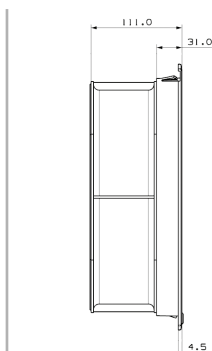
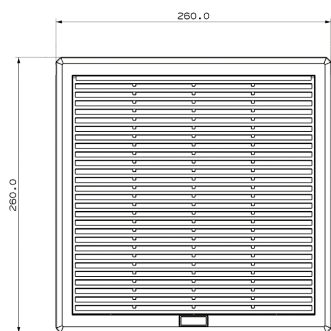



PFI3000



PTF4700



PTF4700

**New**  
**FILTER FANS**  
**700m<sup>3</sup>/h**

MODELS	UNIT	PFI3000	PTF4700
AIR FLOW RATE	m <sup>3</sup> /h	-	700 (950)
POWER SUPPLY	V/Hz	-	230V 50-60Hz
DIMENSIONS	mm	325x325x31	325x325x145
POWER CONSUMPTION	W	-	66 (75)
CURRENT CONSUMPTION	A	-	0.35/0.38
OVERCURRENT PROTECTION	-	-	THERMAL
ELECTRICAL CONNECTION	-	-	4-POLE TERMINAL
OPERATING TEMPERATURE	°C	-10/+70	-10/+70
PROTECTION DEGREE	-	IP54	IP54 / CLASS I
NOISE LEVEL	dB(A)	-	60 (63)
FLOW DIRECTION	-	-	OUTSIDE-IN
BEARING	-	-	BALL
PLASTIC MATERIAL	-	UL94 V0 ABS FLAME RETARDANT	UL94 V0 ABS FLAME RETARDANT
GASKET	-	POLYURETHANE SEALING	POLYURETHANE SEALING
COLOUR	-	RAL7035 (RAL7032 ON REQUEST)	RAL7035 (RAL7032 ON REQUEST)
WEIGHT	kg	0.70	4.12
MOUNTING	-	FAST CLIP-ON	FAST CLIP-ON
CONFORMITY	-	CE	CE

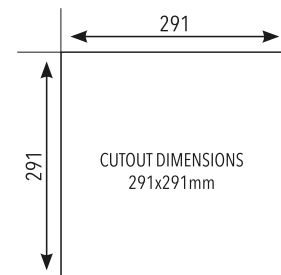
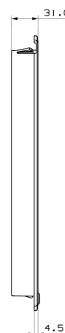
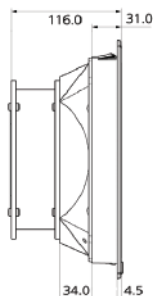
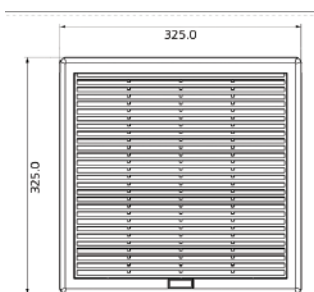



PF13000



PTF5000



PTF5000

# FILTER FANS

850m<sup>3</sup>/h

MODELS	UNIT	PF13000	PTF5000
AIR FLOW RATE	m <sup>3</sup> /h	-	850 (1200)
POWER SUPPLY	V/Hz	-	230V 50-60Hz
DIMENSIONS	mm	325x325x31	325x325x111
POWER CONSUMPTION	W	-	110 (140)
CURRENT CONSUMPTION	A	-	0.350/0.72
OVERCURRENT PROTECTION	-	-	THERMAL
ELECTRICAL CONNECTION	-	-	4-POLE TERMINAL
OPERATING TEMPERATURE	°C	-10/+70	-10/+70
PROTECTION DEGREE	-	IP54	IP54 / CLASS I
NOISE LEVEL	dB(A)	-	65 (68)
FLOW DIRECTION	-	-	OUTSIDE-IN
BEARING	-	-	BALL
PLASTIC MATERIAL	-	UL94 V0 ABS FLAME RETARDANT	UL94 V0 ABS FLAME RETARDANT
GASKET	-	POLYURETHANE SEALING	POLYURETHANE SEALING
COLOUR	-	RAL7035 (RAL7032 ON REQUEST)	RAL7035 (RAL7032 ON REQUEST)
WEIGHT	kg	0.70	4.12
MOUNTING	-	FAST CLIP-ON	FAST CLIP-ON
CONFORMITY	-	CE	CE

